



# 16" PRISMATIC AFL SERIES



## PRAFL16LX

### APPLICATION

16" Arc pendant evokes industrial age designs while using latest LED technology for excellent general illumination. Prismatic refractor provides horizontal and vertical distribution. Laser cut decorative arm.

### FEATURES

Extruded Fixture Housing (EXT) designed for Integral EM features a clean and modern design, with single-stage optical system for smooth light distribution. LED module and driver designed for ease of maintenance and replacement. Posi-lock refractor retention ring will absorb shocks and impacts. Optional safety cable. Variety of mounting methods.

### FINISH

Multi-stage polyester powder-coat process applied on our dedicated paint lines. Variety of standard and custom finishes are available. All exposed materials are chromate pretreated to resist corrosion.

### ELECTRONICS

LED system features high brightness white Nichia LEDs, 3-step MacAdam Ellipse binning. Standard CRI: 80+. Higher CRI, R9 and custom LED configurations are available; consult factory. Variety of electronic 120V/277V and dimming drivers. LED module is 2 circuit with 2 drivers for multicircuit option.

### CONSTRUCTION

Extruded and machined 6063-T5 aluminum housing. Graphite gasket for optimal thermal management. Die-cast aluminum heat sink. Refractor made of cast UV stabilized acrylic. ARC pendant arms and deco ring are laser cut 5052 aluminum.

### CODE COMPLIANCE

BAA compliant. ETL certified to meet US and Canadian standards. Suitable for dry or damp locations. Manufactured and tested to UL standards No. 1598/8750.

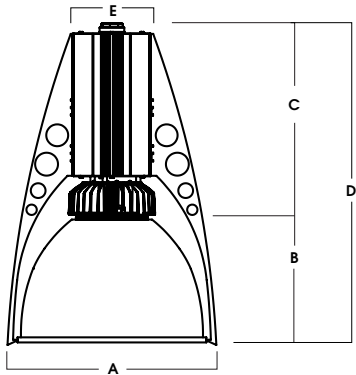

| A        | B        | C        | D        | E        |
|----------|----------|----------|----------|----------|
| 17.5     | 11.8     | 14.6     | 26.4     | 6.5      |
| 444.5 mm | 299.7 mm | 370.8 mm | 670.6 mm | 165.1 mm |

| LUMENS / WATTAGE DATA |                            |                               |              |     |
|-----------------------|----------------------------|-------------------------------|--------------|-----|
| PART NUMBER           | SOURCE LUMENS <sup>1</sup> | DELIVERED LUMENS <sup>2</sup> | SYSTEM WATTS | LPW |
| PRAFL16LX65L          | 6500                       | 5587                          | 56.2         | 99  |
| PRAFL16LX100L         | 10000                      | 8381                          | 81.1         | 103 |
| PRAFL16LX130L         | 13000                      | 11025                         | 103.9        | 106 |
| PRAFL16LX140L         | 14000                      | 11872                         | 111.9        | 106 |

| SERIES    | LUMENS <sup>1</sup> | CCT       | DRIVER / DIMMING <sup>3</sup>   | OPTIONS <sup>4</sup>                          | MOUNTING <sup>5</sup>   | REFRACTOR   | DIFFUSER OPTION         | TIER OPTIONS   | FINISH <sup>9</sup>  |
|-----------|---------------------|-----------|---|---|---|---|-------------------------|--|--|
| PRAFL16LX | 65L 6500 Lm         | 27K 2700K | EX Electronic Driver, 120V/277V<br>DS10X 10%, 0-10V, 120V/277V<br>DO10X 1%, 10-0V, 120V/277V<br>DO103 1%, 0-10V, 347V | SAFETY OPTIONS<br>FS Fusing<br>2CIR 2 Circuit | HM <sup>6</sup> Hang Straight   | DF16 16" Diffuse<br>PR16 16" Clear<br>OP16 16" Opal | TF3 6" Frosted Diffuser | AFPF Aluminum Fins w/ Decorative Perforations and 1-Metal Tier Ring<br>AFSF Aluminum Decorative Arm with Slots and 1-Metal Tier Ring | MW <sup>7</sup> Matte White<br>MB <sup>7</sup> Matte Black<br>PT <sup>7</sup> Platinum Silver<br>CC <sup>7</sup> Custom Color<br>See Page 5 for Full Range of Color Options (83-90081) |
|           | 100L 10000 Lm       | 30K 3000K |   |   | AT <sup>6</sup> Hang Straight All Thread  |   |                         |  |  |
|           | 130L 13000 Lm       | 35K 3500K |   |   | PM <sup>6</sup> Rigid Pendant   |   |                         |  |  |
|           | 140L 14000 Lm       | 40K 4000K |   |   | CD <sup>6</sup> Cord / Cable Mount<br>HC <sup>6</sup> Hook & Cord<br>NM2 <sup>7</sup> ½" NPT Hub<br>NM3 <sup>7</sup> ¾" NPT Hub |   |                         |  |  |
|           |                     |           |   |   | EMERGENCY BATTERY OPTIONS   |   |                         |  |  |
|           |                     |           |   |   | EMIT 7W Emergency Battery Test Switch<br>EMCR 10W Canopy Mounted EM<br>EMRM 7W Remote EM<br>EMEN 7W Remote with Enclosure       |   |                         |  |  |

**EXAMPLE:** PRAFL16LX100L35KEX/CD36/PR16/AFPF/MB

**NOTES:**  
 1 Nominal Source Lumens at 35K 2 Nominal Delivered Lumens at 35K with PR16AFPFMW 3 Contact Factory for Additional Options 4 See Product Options Page For Details 5 See Mounting Page for Details on Components and Finishes  
 6 Specify Length in Inches: See Mounting Page for Available Lengths 7 Mounting Supplied by Others 8 See Color Page for More Options / Consult Factory for Special Finishes 9 Standard Finishes



PROJECT: \_\_\_\_\_  
 TYPE: \_\_\_\_\_



Dimensions and values shown are nominal. Spectrum Lighting continually works to improve products and reserves the right to make changes which may alter the performance or appearance of products.

# 16" PRISMATIC

## ARC SERIES / FIXTURE OPTIONS



### STANDARD FINISHES

**MW**  
MATTE WHITE



**MB**  
MATTE BLACK



**PT**  
PLATINUM SILVER



### DECORATIVE ARMS

**AFPF**  
LASER CUT DECO ARM WITH HOLES

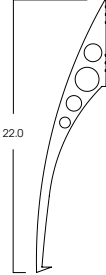

**AFSF**  
LASER CUT DECO ARM WITH SLOTS

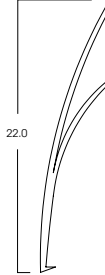

### MOUNTING TYPES

**HM / AT / PM**  
HANG STRAIGHT / ALL THREAD / PENDANT

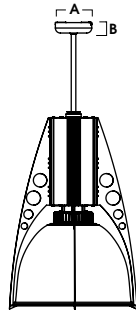

| A      | B       |
|--------|---------|
| 5.0    | 1.5     |
| 127 mm | 38.1 mm |

**CD**  
CORD / CABLE MOUNT

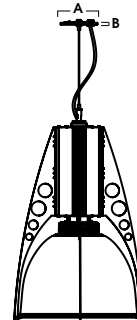

| A       | B       |
|---------|---------|
| 5.0     | .25     |
| 63.5 mm | 6.35 mm |

**HC**  
HOOK CORD

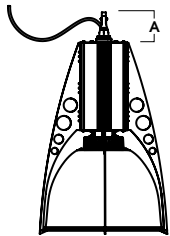

| A        |
|----------|
| 4.0      |
| 101.6 mm |

**NM**  
NO MOUNT

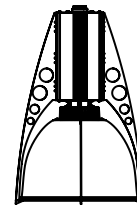



# MOUNTING & ACCESSORIES

SOME OPTIONS NOT AVAILABLE ON ALL FIXTURES. CONSULT SPECIFICATION SHEETS. SEE INDIVIDUAL SPECIFICATION SHEETS OR CONSULT FACTORY FOR ADDITIONAL INFORMATION. NOTE: THIS IS TYPICAL OF RLM SPECIFICATION FOR MOUNTING. INDIVIDUAL FIXTURES OR PROJECTS MAY HAVE SPECIALIZED REQUIREMENTS.



## ADDITIONS

|  |   |
|--|---|
| <p><b>FS - FUSING</b></p> <p>Slow blow type fuse protects fixture against voltage surges. Factory installed.</p>  | <p><b>LSP10 - SM - SURGE PROTECTOR</b></p> <p>Surge protector absorbs transient electrical spikes and protects fixtures and electronics 120/277v. Re-sets after surge. Factory Installed.</p>  |
|--|---|



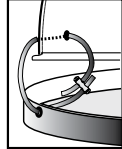

## SAFETY CABLE OPTIONS

|  |   |
|--|---|
| <p><b>SC1 - SAFETY CABLE</b></p> <p>1/16" stainless steel safety cable for added support. Standard kit is 18" and double barrel locks are provided. Approved for California seismic requirements. Rated at 50 lbs.</p>  | <p><b>SC2 - SAFETY CABLE</b></p> <p>1/16" Stainless steel cable holds door to fixture</p>  |
|--|---|

## OPTIONS

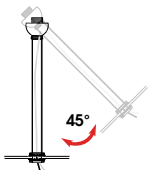
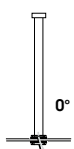
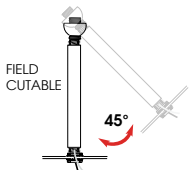
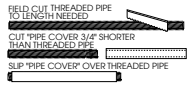
|  |  |
|--|--|
| <p><b>DIFFUSER</b></p> <p><b>TF3-6"</b> Frosted Diffuser</p>  | <p><b>TIER OPTIONS</b></p> <p><b>APPF</b>-Aluminum Fins w/ Decorative Perforations and 1-Metal Tier Ring<br/> <b>AFSF</b>-Aluminum Decorative Arm with Slots and 1-Metal Tier Ring</p> |
|--|--|

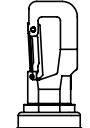
## MOUNTING TYPES

|   |  |   |   |  |  |
|---|--|---|---|--|--|
| <p><b>HM*</b><br/>HANG STRAIGHT<br/>45° SWIVEL 5/8" OD STEM - 3/8" IP</p>  <p>ORDER: <b>HM</b> (Length)<br/>SPECIFY LENGTH:<br/> <b>HM3</b> - 3"    <b>HM24</b> - 24"<br/> <b>HM6</b> - 6"    <b>HM36</b> - 36"<br/> <b>HM12</b> - 12"    <b>HM48</b> - 48"<br/> <b>HM18</b> - 18"    <b>HM72</b> - 72"<br/> <b>HMLC(XX)</b><br/>         Custom Length<br/>         (Specify in Inches)</p> | <p><b>PM*</b><br/>RIGID PENDANT MOUNT<br/>RIGID 5/8" OD STEM - 3/8" IP</p>  <p>ORDER: <b>PM</b> (Length)<br/>SPECIFY LENGTH:<br/> <b>PM3</b> - 3"    <b>PM24</b> - 24"<br/> <b>PM6</b> - 6"    <b>PM36</b> - 36"<br/> <b>PM12</b> - 12"    <b>PM48</b> - 48"<br/> <b>PM18</b> - 18"    <b>PM72</b> - 72"<br/> <b>PMLC(XX)</b><br/>         Custom Length<br/>         (Specify in Inches)</p> | <p><b>AT**</b><br/>HANG STRAIGHT ALL THREAD<br/>45° SWIVEL 5/8" OD STEM - 1/4" IP</p>  <p>ORDER: <b>AT</b> (Length)<br/>SPECIFY LENGTH:<br/> <b>AT12</b> - 12"<br/> <b>AT24</b> - 24"<br/> <b>AT36</b> - 36"</p>  | <p><b>CD</b><br/>CORD / CABLE MOUNT<br/>SJ CORD WITH 1/16 SS CABLE</p>  <p>ORDER: <b>CD</b> (Length)<br/>SPECIFY LENGTH:<br/> <b>CD36</b> - 36"<br/> <b>CD72</b> - 72"<br/> <b>CD144</b> - 144"<br/> <b>CDLC(XX)</b><br/>         Custom Length<br/>         (Specify in Inches)</p> | <p><b>HC</b><br/>HOOK &amp; CORD<br/>FOR INDEPENDENT MOUNTING</p>  <p>ORDER: <b>HC</b> (Length)<br/>SPECIFY LENGTH:<br/> <b>HC36</b> - 36"<br/> <b>HC72</b> - 72"<br/> <b>HC144</b> - 144"<br/> <b>HCLC(XX)</b><br/>         Custom Length<br/>         (Specify in Inches)</p> | <p><b>NMX</b><br/>1/2" NPT Hub<br/>3/4" NPT Hub<br/>FOR INDEPENDENT MOUNTING</p>  <p>ORDER: <b>NMX</b> (Length)<br/>SPECIFY LENGTH:<br/> <b>NM2(12)</b> - 12" Leads are Standard<br/> <b>NM3(12)</b> - 12" Leads are Standard<br/> <b>NMXLC(XX)</b><br/>         Custom Length<br/>         (Specify in Inches)</p> |
|---|--|---|---|--|--|

\*MAXIMUM ONE PIECE STEM LENGTH IS 72". \*\*MAXIMUM ONE PIECE STEM LENGTH IS 36". LONGER LENGTHS ARE POSSIBLE USING MULTIPLE STEMS AND COUPLERS.

## EMERGENCY BATTERY OPTIONS

**EMCR - LARGE DRIVER CANOPY FOR 10W EMERGENCY BATTERY**

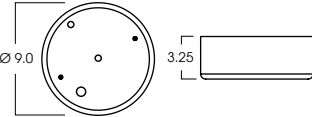

|     |      |      |
|-----|------|------|
| A   | B    | C    |
| 1.3 | 12.6 | 13.0 |

## REMOTE EMERGENCY BATTERY OPTIONS

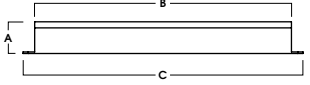
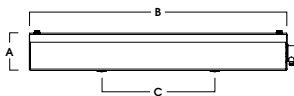
|   |      |      |   |     |      |      |  |   |   |   |     |      |     |
|---|------|------|---|-----|------|------|--|---|---|---|-----|------|-----|
| <p><b>EMRM* - 7W REMOTE EMERGENCY BATTERY (60' MAX)</b></p>  <table border="1"> <tr> <td>A</td> <td>B</td> <td>C</td> </tr> <tr> <td>1.3</td> <td>12.6</td> <td>13.0</td> </tr> </table> | A    | B    | C | 1.3 | 12.6 | 13.0 | <p><b>EMEN* - 7W REMOTE EMERGENCY BATTERY WITH ENCLOSURE (60' MAX)</b></p>  <table border="1"> <tr> <td>A</td> <td>B</td> <td>C</td> </tr> <tr> <td>2.0</td> <td>17.0</td> <td>6.2</td> </tr> </table> | A | B | C | 2.0 | 17.0 | 6.2 |
| A   | B    | C    |   |     |      |      |  |   |   |   |     |      |     |
| 1.3   | 12.6 | 13.0 |   |     |      |      |  |   |   |   |     |      |     |
| A   | B    | C    |   |     |      |      |  |   |   |   |     |      |     |
| 2.0   | 17.0 | 6.2  |   |     |      |      |  |   |   |   |     |      |     |

\*OTHER EM BATTERY SIZES AVAILABLE. CONSULT FACTORY

# 16" PRISMATIC

## AFL SERIES / PHOTOMETRIC DATA



PRAF-L-16LEDLX-140L-35K-E1-PR16-AFPF (or AFSF)-MW

| CANDLEPOWER CURVE | INTENSITY                  | ZONAL LUMENS        |        | SINGLE UNIT: PERFORMANCE                              |                     |                       |               | MULTIPLE UNITS: PERFORMANCE   |   |                 |       |           |       |           |
|-------------------|----------------------------|---------------------|--------|---|---------------------|-----------------------|---------------|---|---|-----------------|-------|-----------|-------|-----------|
|                   |                            |                     |        | INITIAL FOOTCANDLES<br>BASED ON IES BEAM ANGLE        |                     |                       |               | 80/50/20% REFLECTANCES<br>INITIAL FOOTCANDLES AND WATTS PER SQUARE FOOT |   |                 |       |           |       |           |
|                   | 0.00°                      | 0° - 10°            | 1,468  | 12%   | Mounting Height AFF | FC at Center on Floor | Beam Diameter | FC at Beam Edge   | Ceiling Height                                      | Fixture Spacing | RCR 2 |           | RCR 4 |           |
|                   | 0.00° 12,966               | 0° - 20°            | 4,591  | 38%   |                     |                       |               |   |   |                 | FC +  | W/Sq. Ft. | FC +  | W/Sq. Ft. |
|                   | 5.00° 12,913               | 0° - 30°            | 8,092  | 68%   | 10.0'               | 130 fc                | 10.7'         | 64 fc   | 22'   | 16'*            | 49    | 0.47      | 61    | 0.67      |
|                   | 10.00° 12,640              | 0° - 40°            | 10,183 | 85%   | 12.0'               | 90 fc                 | 12.9'         | 45 fc   | 26'   | 18''            | 31    | 0.29      | 39    | 0.42      |
|                   | 15.00° 11,552              | 0° - 60°            | 11,265 | 94%   | 14.0'               | 66 fc                 | 15.0'         | 33 fc   | 32'   | 20''*           | 26    | 0.25      | 23    | 0.25      |
|                   | 20.00° 9,689               | 0° - 80°            | 11,597 | 97%   | 16.0'               | 51 fc                 | 17.2'         | 25 fc   | Delivered Illuminance Rating: (DIR)                 |                 |       |           |       |           |
|                   | 30.00° 5,746               | 0° - 90°            | 11,646 | 97%   | 20.0'               | 32 fc                 | 21.5'         | 16 fc   | 2' Suspension Length                                |                 |       |           |       |           |
|                   | 40.00° 1,465               | Total               | 11,976 | 100%  | 24.0'               | 23 fc                 | 25.8'         | 11 fc   | Square rooms used for multiple units:               |                 |       |           |       |           |
|                   | 50.00° 535                 |                     |        |   | 28.0'               | 17 fc                 | 30.1'         | 8 fc  | - RCR 2: Length & Width = Ceiling Ht. - 6.5' x 5.00 |                 |       |           |       |           |
|                   | 60.00° 308                 |                     |        |   | 32.0'               | 13 fc                 | 34.4'         | 6 fc  | - RCR 4: Length & Width = Ceiling Ht. - 6.5' x 2.50 |                 |       |           |       |           |
|                   | 70.00° 156                 |                     |        |   |                     |                       |               |   | + Average Footcandles at 2.5' Above Floor           |                 |       |           |       |           |
|                   | 80.00° 59                  |                     |        |   |                     |                       |               |   | * Exceeds spacing criteria by 19%                   |                 |       |           |       |           |
| 90.00° 42         |                            |                     |        |   |                     |                       |               | ** Exceeds spacing criteria by 6%                                       |   |                 |       |           |       |           |
|                   |                            |                     |        |   |                     |                       |               | *** Exceeds spacing criteria by -10%                                    |   |                 |       |           |       |           |
|                   | CP at 0deg (Nadir): 12,966 | Beam Angle: 56.3    |        | Lamp Multiplier: 65L x 0.47, 100L x 0.71, 130L x 0.93 |                     |                       |               |   |   |                 |       |           |       |           |
|                   | CRI: 85+                   | Spacing Ratio: 0.87 |        | CCT Multiplier: 27K x 0.959, 30K x 0.979, 40K x 1.03  |                     |                       |               |   |   |                 |       |           |       |           |

Delivered Lumens: 11,976  
Luminaire Watts: 111.89  
LER: 107.03

# COLOR OPTIONS - POWDER COAT PAINT FINISHES

NOTE: NO PRINTED IMAGE CAN EQUAL THE EXACT COLOR OF FINISH ON METAL.  
SEE INDIVIDUAL SPECIFICATION SHEETS OR CONSULT FACTORY FOR ADDITIONAL INFORMATION.



## STANDARD CORD / STEM / CANOPY FINISHES

| FIXTURE COLOR                            | STANDARD CORD COLOR | STANDARD CANOPY / STEM COLOR |
|--|---------------------|------------------------------|
| Matte White, Textured White              | Matte White         | Matte White                  |
| Gloss White                              | Matte White         | Gloss White                  |
| Matte Black, Gloss Black, Textured Black | Matte Black         | Matte Black                  |
| All Others                               | Matte Black         | Same Color as Fixture        |
| Custom Color                             | Contact Factory     | Contact Factory              |

## PAINT TIMES

| TIER                       | COST            | AVERAGE PAINT TIME* |
|----------------------------|-----------------|---------------------|
| Tier 1 - Standard Finishes | \$              | ⌚                   |
| Tier 2 - Typical Finishes  | \$\$            | ⌚⌚                  |
| Custom Color               | Contact Factory | Contact Factory     |

\*CONTACT FACTORY FOR SPECIFIC PRODUCT LEAD TIMES

## TIER 1 - STANDARD FINISHES

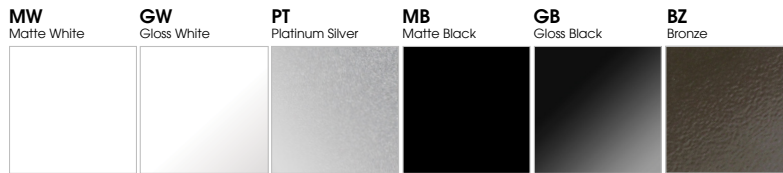

## TIER 2 - TYPICAL FINISHES

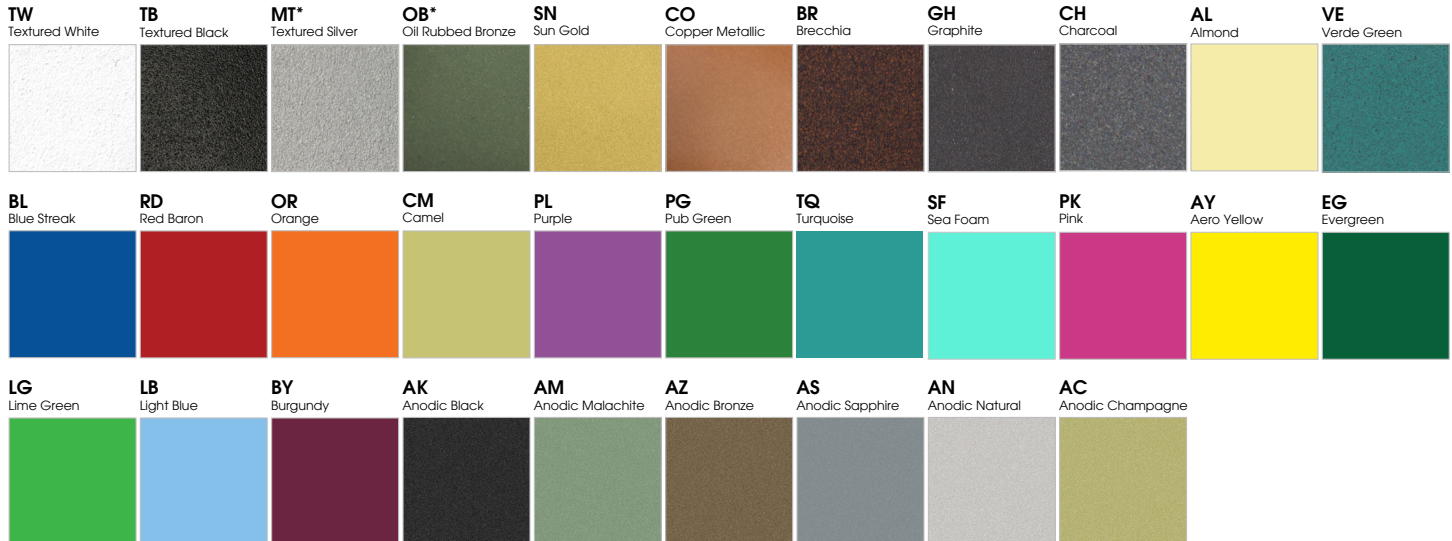

## CUSTOM COLOR FINISHES

CONTACT FACTORY

**CC**  
Custom Color



\*UNAVAILABLE FOR WET LOCATION