



16" PRISMATIC DDH SERIES



PRDDH16INC4X

APPLICATION

16" Lumen Max series performance pendant for low and mid-bay applications. Prismatic refractor provides horizontal and vertical distribution.

FEATURES

Domed Fixture Housing (DDH) features a contemporary design that is easy to maintain. Post-lock refractor retention ring will absorb shocks and impact. Optional safety cable. Variety of optical lenses and mounting methods.

FINISH

Multi-stage polyester powder-coat process applied on our dedicated paint lines. Variety of standard and custom finishes are available. All exposed materials are chromate pretreated to resist corrosion.

ELECTRONICS

Medium base incandescent socket. Max wattage 100W.

CONSTRUCTION

Spun aluminum housing with die-cast aluminum and mounting hub. Refractor made of cast UV stabilized acrylic.

CODE COMPLIANCE

BAA compliant. ETL certified to meet US and Canadian standards. Suitable for dry or damp locations. Manufactured and tested to UL standards No. 1598/8750.

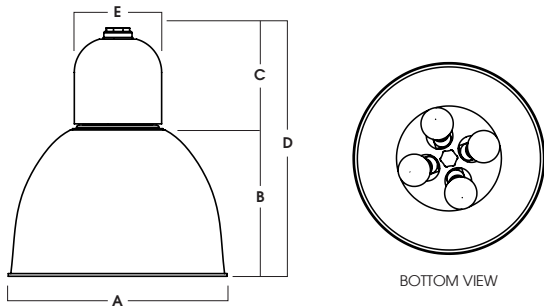

A	B	C	D	E
16.0	11.0	7.0	18.0	6.5
406.4 mm	279.4 mm	177.8 mm	457.2 mm	165.1 mm

LUMENS / WATTAGE DATA				
PART NUMBER	SOURCE LUMENS ¹	DELIVERED LUMENS ²	SYSTEM WATTS	LPW
PRDDH16INC4X	6500	6043	72	84

SERIES	MOUNTING ³	REFRACTOR	DIFFUSER OPTIONS		FINISH ⁹
PRDDH16INC4X	HM⁴ Hang Straight PM⁴ Rigid Pendant CD⁴ Cord / Cable Mount SC1 Safety Cable SC2 Safety Cable, Refractor to Door HC^{4/5} Hook and Cord NM2^{5/6} 1/2" Hub NM3^{5/6} 3/4" Hub	PR16 16" Clear Prismatic OP16 16" Opal Etch DF16 16" Diffuse	DOOR		MW¹⁰ Matte White MB¹⁰ Matte Black PT¹⁰ Platinum Silver See Page 5 for Full Range of Color Options (83-90081)
			DR16D⁷ 16" Spun Door BC16 16" Band Clamp RS16⁸ 16" Refractor Shroud	LENS	
			CNFR Conical Frosted Lens CN Conical Lens DL Drop Lens FO White Optical Acrylic PP Prismatic Polycarbonate PC Clear Polycarbonate WAG16 16" Wire Guard		

EXAMPLE: PRDDH16INC4X/HM36/PR16/MW

NOTES:
 1 Nominal Source Lumens 2 Nominal Delivered Lumens 3 See Mounting Page for Details on Components and Finishes 4 Specify Length in Inches: See Mounting Page for Available Lengths 5 Mounting Supplied by Others
 6 12" Leads Unless Specified 7 Same Finish as Housing 8 Same Finish as Housing / For Use with Prismatic Shades Only 9 See Color Page for More Options/Consult Factory for Special Finishes 10 Standard Finishes



PROJECT: _____
 TYPE: _____



Dimensions and values shown are nominal. Spectrum Lighting continually works to improve products and reserves the right to make changes which may alter the performance or appearance of products.

16" PRISMATIC

DDH SERIES / FIXTURE OPTIONS



STANDARD FINISHES

MW
MATTE WHITE



MB
MATTE BLACK



PT
PLATINUM SILVER



MOUNTING TYPES

HM / PM
HANG STRAIGHT / PENDANT

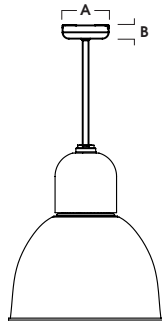

A	B
5.4	2.5
137.2 mm	63.5 mm

CD
CORD / CABLE MOUNT

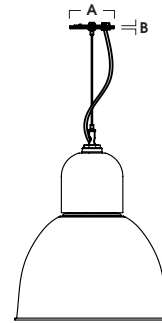

A	B
5.0	.25
127.0 mm	6.4 mm

HC
HOOK CORD

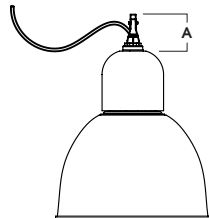

A
4.2
106.7 mm

NM
NO MOUNT

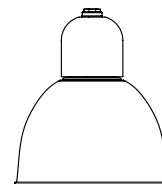

16" PRISMATIC

DDH SERIES / PHOTOMETRIC DATA



PRDDH16INC4X-CD120-DF16-MW

CANDLEPOWER CURVE	INTENSITY	ZONAL LUMENS	SINGLE UNIT: PERFORMANCE INITIAL FOOTCANDLES BASED ON IES BEAM ANGLE	MULTIPLE UNITS: PERFORMANCE 80/50/20% REFLECTANCES INITIAL FOOTCANDLES AND WATTS PER SQUARE FOOT																													
	0.00°	0° - 10°	90	1%	<table border="1"> <thead> <tr> <th rowspan="2">Ceiling Height</th> <th rowspan="2">Fixture Spacing</th> <th colspan="2">RCR 2</th> <th colspan="2">RCR 3</th> </tr> <tr> <th>FC +</th> <th>W/Sq. Ft.</th> <th>FC +</th> <th>W/Sq. Ft.</th> </tr> </thead> <tbody> <tr> <td>8'</td> <td>6'</td> <td>138</td> <td>2.12</td> <td>120</td> <td>2.12</td> </tr> <tr> <td>8'</td> <td>8'</td> <td>62</td> <td>0.94</td> <td>120</td> <td>2.12</td> </tr> <tr> <td>8'</td> <td>10'</td> <td>62</td> <td>0.94</td> <td>30</td> <td>0.53</td> </tr> </tbody> </table>	Ceiling Height	Fixture Spacing	RCR 2		RCR 3		FC +	W/Sq. Ft.	FC +	W/Sq. Ft.	8'	6'	138	2.12	120	2.12	8'	8'	62	0.94	120	2.12	8'	10'	62	0.94	30	0.53
	Ceiling Height	Fixture Spacing	RCR 2					RCR 3																									
			FC +	W/Sq. Ft.		FC +	W/Sq. Ft.																										
	8'	6'	138	2.12	120	2.12																											
	8'	8'	62	0.94	120	2.12																											
	8'	10'	62	0.94	30	0.53																											
	0.00° 925	0° - 20°	361	6%	<table border="1"> <thead> <tr> <th rowspan="2">Mounting Height AFF</th> <th rowspan="2">FC at Center on Floor</th> </tr> </thead> <tbody> <tr> <td>5.5'</td> <td>31 fc</td> </tr> </tbody> </table>	Mounting Height AFF	FC at Center on Floor	5.5'	31 fc																								
	Mounting Height AFF	FC at Center on Floor																															
			5.5'	31 fc																													
	20.00° 974	0° - 30°	827	14%	<table border="1"> <thead> <tr> <th rowspan="2">Mounting Height AFF</th> <th rowspan="2">FC at Center on Floor</th> </tr> </thead> <tbody> <tr> <td>7.5'</td> <td>16 fc</td> </tr> </tbody> </table>	Mounting Height AFF	FC at Center on Floor	7.5'	16 fc																								
	Mounting Height AFF	FC at Center on Floor																															
			7.5'	16 fc																													
	40.00° 1,028	0° - 40°	1,481	25%	<table border="1"> <thead> <tr> <th rowspan="2">Mounting Height AFF</th> <th rowspan="2">FC at Center on Floor</th> </tr> </thead> <tbody> <tr> <td>10.0'</td> <td>9 fc</td> </tr> </tbody> </table>	Mounting Height AFF	FC at Center on Floor	10.0'	9 fc																								
Mounting Height AFF	FC at Center on Floor																																
		10.0'	9 fc																														
60.00° 704	0° - 60°	2,967	49%	<table border="1"> <thead> <tr> <th rowspan="2">Mounting Height AFF</th> <th rowspan="2">FC at Center on Floor</th> </tr> </thead> <tbody> <tr> <td>12.0'</td> <td>6 fc</td> </tr> </tbody> </table>	Mounting Height AFF	FC at Center on Floor	12.0'	6 fc																									
Mounting Height AFF	FC at Center on Floor																																
		12.0'	6 fc																														
80.00° 435	0° - 80°	4,031	67%	<table border="1"> <thead> <tr> <th rowspan="2">Delivered Illuminance Rating: (DIR)</th> <th colspan="2">65 FC per W/Sq. Ft.</th> <th colspan="2">57 FC per W/Sq. Ft.</th> </tr> </thead> <tbody> <tr> <td>2' Suspension Length Square rooms used for multiple units: - RCR 2: Length & Width = Ceiling Ht. - 4.5' x 5.00 - RCR 3: Length & Width = Ceiling Ht. - 4.5' x 3.33 + Average Footcandles at 2.5' Above Floor * Exceeds spacing criteria by 3% ** Exceeds spacing criteria by 38% *** Exceeds spacing criteria by 72%</td> <td colspan="2"></td> <td colspan="2"></td> </tr> </tbody> </table>	Delivered Illuminance Rating: (DIR)	65 FC per W/Sq. Ft.		57 FC per W/Sq. Ft.		2' Suspension Length Square rooms used for multiple units: - RCR 2: Length & Width = Ceiling Ht. - 4.5' x 5.00 - RCR 3: Length & Width = Ceiling Ht. - 4.5' x 3.33 + Average Footcandles at 2.5' Above Floor * Exceeds spacing criteria by 3% ** Exceeds spacing criteria by 38% *** Exceeds spacing criteria by 72%																							
Delivered Illuminance Rating: (DIR)	65 FC per W/Sq. Ft.		57 FC per W/Sq. Ft.																														
	2' Suspension Length Square rooms used for multiple units: - RCR 2: Length & Width = Ceiling Ht. - 4.5' x 5.00 - RCR 3: Length & Width = Ceiling Ht. - 4.5' x 3.33 + Average Footcandles at 2.5' Above Floor * Exceeds spacing criteria by 3% ** Exceeds spacing criteria by 38% *** Exceeds spacing criteria by 72%																																
90.00° 406	0° - 90°	4,487	74%	<p>Lamp Multiplier: 1.0 for 18W CCT Multiplier: 1.0 for 30K</p>																													
100.00° 392	Total	6,043	100%																														
110.00° 372																																	
120.00° 339																																	
140.00° 40																																	
160.00° 13																																	
180.00° 11																																	

Delivered Lumens: 6,043
Luminaire Watts: 72
LER: 83.93

CP at 0deg (Nadir): 925
CRI: 80

Lamp Multiplier: 1.0 for 18W
CCT Multiplier: 1.0 for 30K

PRDDH16INC4X-CD120-DF16-CN-MW

CANDLEPOWER CURVE	INTENSITY	ZONAL LUMENS	SINGLE UNIT: PERFORMANCE INITIAL FOOTCANDLES BASED ON IES BEAM ANGLE	MULTIPLE UNITS: PERFORMANCE 80/50/20% REFLECTANCES INITIAL FOOTCANDLES AND WATTS PER SQUARE FOOT																													
	0.00°	0° - 10°	71	1%	<table border="1"> <thead> <tr> <th rowspan="2">Ceiling Height</th> <th rowspan="2">Fixture Spacing</th> <th colspan="2">RCR 2</th> <th colspan="2">RCR 3</th> </tr> <tr> <th>FC +</th> <th>W/Sq. Ft.</th> <th>FC +</th> <th>W/Sq. Ft.</th> </tr> </thead> <tbody> <tr> <td>8'</td> <td>6'</td> <td>123</td> <td>2.12</td> <td>106</td> <td>2.12</td> </tr> <tr> <td>8'</td> <td>8'</td> <td>55</td> <td>0.94</td> <td>106</td> <td>2.12</td> </tr> <tr> <td>8'</td> <td>10'</td> <td>55</td> <td>0.94</td> <td>27</td> <td>0.53</td> </tr> </tbody> </table>	Ceiling Height	Fixture Spacing	RCR 2		RCR 3		FC +	W/Sq. Ft.	FC +	W/Sq. Ft.	8'	6'	123	2.12	106	2.12	8'	8'	55	0.94	106	2.12	8'	10'	55	0.94	27	0.53
	Ceiling Height	Fixture Spacing	RCR 2					RCR 3																									
			FC +	W/Sq. Ft.		FC +	W/Sq. Ft.																										
	8'	6'	123	2.12	106	2.12																											
	8'	8'	55	0.94	106	2.12																											
	8'	10'	55	0.94	27	0.53																											
	0.00° 735	0° - 20°	278	5%	<table border="1"> <thead> <tr> <th rowspan="2">Mounting Height AFF</th> <th rowspan="2">FC at Center on Floor</th> </tr> </thead> <tbody> <tr> <td>5.5'</td> <td>24 fc</td> </tr> </tbody> </table>	Mounting Height AFF	FC at Center on Floor	5.5'	24 fc																								
	Mounting Height AFF	FC at Center on Floor																															
			5.5'	24 fc																													
	20.00° 727	0° - 30°	620	11%	<table border="1"> <thead> <tr> <th rowspan="2">Mounting Height AFF</th> <th rowspan="2">FC at Center on Floor</th> </tr> </thead> <tbody> <tr> <td>7.5'</td> <td>13 fc</td> </tr> </tbody> </table>	Mounting Height AFF	FC at Center on Floor	7.5'	13 fc																								
	Mounting Height AFF	FC at Center on Floor																															
			7.5'	13 fc																													
	40.00° 752	0° - 40°	1,097	20%	<table border="1"> <thead> <tr> <th rowspan="2">Mounting Height AFF</th> <th rowspan="2">FC at Center on Floor</th> </tr> </thead> <tbody> <tr> <td>10.0'</td> <td>7 fc</td> </tr> </tbody> </table>	Mounting Height AFF	FC at Center on Floor	10.0'	7 fc																								
Mounting Height AFF	FC at Center on Floor																																
		10.0'	7 fc																														
60.00° 590	0° - 60°	2,220	40%	<table border="1"> <thead> <tr> <th rowspan="2">Mounting Height AFF</th> <th rowspan="2">FC at Center on Floor</th> </tr> </thead> <tbody> <tr> <td>12.0'</td> <td>5 fc</td> </tr> </tbody> </table>	Mounting Height AFF	FC at Center on Floor	12.0'	5 fc																									
Mounting Height AFF	FC at Center on Floor																																
		12.0'	5 fc																														
80.00° 457	0° - 80°	3,285	59%	<table border="1"> <thead> <tr> <th rowspan="2">Delivered Illuminance Rating: (DIR)</th> <th colspan="2">58 FC per W/Sq. Ft.</th> <th colspan="2">50 FC per W/Sq. Ft.</th> </tr> </thead> <tbody> <tr> <td>2' Suspension Length Square rooms used for multiple units: - RCR 2: Length & Width = Ceiling Ht. - 4.5' x 5.00 - RCR 3: Length & Width = Ceiling Ht. - 4.5' x 3.33 + Average Footcandles at 2.5' Above Floor * Exceeds spacing criteria by 10% ** Exceeds spacing criteria by 47% *** Exceeds spacing criteria by 83%</td> <td colspan="2"></td> <td colspan="2"></td> </tr> </tbody> </table>	Delivered Illuminance Rating: (DIR)	58 FC per W/Sq. Ft.		50 FC per W/Sq. Ft.		2' Suspension Length Square rooms used for multiple units: - RCR 2: Length & Width = Ceiling Ht. - 4.5' x 5.00 - RCR 3: Length & Width = Ceiling Ht. - 4.5' x 3.33 + Average Footcandles at 2.5' Above Floor * Exceeds spacing criteria by 10% ** Exceeds spacing criteria by 47% *** Exceeds spacing criteria by 83%																							
Delivered Illuminance Rating: (DIR)	58 FC per W/Sq. Ft.		50 FC per W/Sq. Ft.																														
	2' Suspension Length Square rooms used for multiple units: - RCR 2: Length & Width = Ceiling Ht. - 4.5' x 5.00 - RCR 3: Length & Width = Ceiling Ht. - 4.5' x 3.33 + Average Footcandles at 2.5' Above Floor * Exceeds spacing criteria by 10% ** Exceeds spacing criteria by 47% *** Exceeds spacing criteria by 83%																																
90.00° 428	0° - 90°	3,765	67%	<p>Lamp Multiplier: 1.0 for 18W CCT Multiplier: 1.0 for 30K</p>																													
100.00° 431	Total	5,581	100%																														
110.00° 430																																	
120.00° 404																																	
140.00° 80																																	
160.00° 9																																	
180.00° 10																																	

Delivered Lumens: 5,581
Luminaire Watts: 72
LER: 77.51

CP at 0deg (Nadir): 735
CRI: 80





Lamp Multiplier: 1.0 for 18W
CCT Multiplier: 1.0 for 30K

MOUNTING & ACCESSORIES

SOME OPTIONS NOT AVAILABLE ON ALL FIXTURES. CONSULT SPECIFICATION SHEETS. SEE INDIVIDUAL SPECIFICATION SHEETS OR CONSULT FACTORY FOR ADDITIONAL INFORMATION. NOTE: THIS IS TYPICAL OF RLM SPECIFICATION FOR MOUNTING. INDIVIDUAL FIXTURES OR PROJECTS MAY HAVE SPECIALIZED REQUIREMENTS.

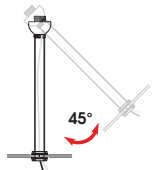
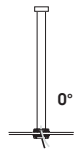

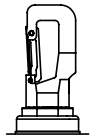
MOUNTING TYPES

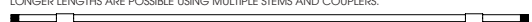
<p>HM* HANG STRAIGHT 45° SWIVEL 5/8" OD STEM - 3/8" IP</p>  <p>ORDER: HM (Length) SPECIFY LENGTH: HM3 - 3" HM24 - 24" HM6 - 6" HM36 - 36" HM12 - 12" HM48 - 48" HM18 - 18" HM72 - 72" HMLC(XX) Custom Length (Specify in Inches)</p>	<p>PM* RIDGID PENDANT MOUNT RIGID 5/8" OD STEM - 3/8" IP</p>  <p>ORDER: PM (Length) SPECIFY LENGTH: PM3 - 3" PM24 - 24" PM6 - 6" PM36 - 36" PM12 - 12" PM48 - 48" PM18 - 18" PM72 - 72" PMLC(XX) Custom Length (Specify in Inches)</p>	<p>CD CORD / CABLE MOUNT SJ CORD WITH 1/16 SS CABLE</p>  <p>ORDER: CD (Length) SPECIFY LENGTH: CD36 - 36" CD72 - 72" CD144 - 144" CDLC(XX) Custom Length (Specify in Inches)</p>	<p>HC HOOK & CORD FOR INDEPENDENT MOUNTING</p>  <p>ORDER: HC (Length) SPECIFY LENGTH: HC36 - 36" HC72 - 72" HC144 - 144" HC LC(XX) Custom Length (Specify in Inches)</p>	<p>NMX 1/2" NPT Hub 3/4" NPT Hub FOR INDEPENDENT MOUNTING</p>  <p>ORDER: NMX (Length) SPECIFY LENGTH: NM2(12) - 12" Leads are Standard NM3(12) - 12" Leads are Standard NMXLC(XX) Custom Length (Specify in Inches)</p>
<p>*MAXIMUM ONE PIECE STEM LENGTH IS 72". **MAXIMUM ONE PIECE STEM LENGTH IS 36". LONGER LENGTHS ARE POSSIBLE USING MULTIPLE STEMS AND COUPLERS.</p> 				

SAFETY CABLE OPTIONS

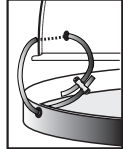
<p>SC1 - SAFETY CABLE</p> <p>1/16" stainless steel safety cable for added support. Standard kit is 18" and double barrel locks are provided. Approved for California seismic requirements. Rated at 50 lbs.</p> 	<p>SC2 - SAFETY CABLE</p> <p>1/16" Stainless steel cable holds door to fixture</p> 
--	---

COLOR OPTIONS - POWDER COAT PAINT FINISHES

NOTE: NO PRINTED IMAGE CAN EQUAL THE EXACT COLOR OF FINISH ON METAL.
SEE INDIVIDUAL SPECIFICATION SHEETS OR CONSULT FACTORY FOR ADDITIONAL INFORMATION.



STANDARD CORD / STEM / CANOPY FINISHES

FIXTURE COLOR	STANDARD CORD COLOR	STANDARD CANOPY / STEM COLOR
Matte White, Textured White	Matte White	Matte White
Gloss White	Matte White	Gloss White
Matte Black, Gloss Black, Textured Black	Matte Black	Matte Black
All Others	Matte Black	Same Color as Fixture
Custom Color	Contact Factory	Contact Factory

PAINT TIMES

TIER	COST	AVERAGE PAINT TIME*
Tier 1 - Standard Finishes	\$	⌚
Tier 2 - Typical Finishes	\$\$	⌚⌚
Custom Color	Contact Factory	Contact Factory

*CONTACT FACTORY FOR SPECIFIC PRODUCT LEAD TIMES

TIER 1 - STANDARD FINISHES



TIER 2 - TYPICAL FINISHES



CUSTOM COLOR FINISHES

CONTACT FACTORY

CC
Custom Color



*UNAVAILABLE FOR WET LOCATION