



22" ALUMINUM EXL SERIES



ALEXL22LX

APPLICATION

22" Lumen Max LX series performance pendant for low, mid-bay and high-bay applications. Aluminum reflector designed for maximum downlight.

FEATURES

Extruded Fixture Housing (EXL) designed for Integral EM features a clean and modern design. Single-stage optical system for smooth light distribution. LED module and driver designed for ease of maintenance and replacement. Posi-lock reflector retention ring will absorb shocks and impact. Optional safety cable. Variety of optical lenses and mounting methods.

FINISH

Multi-stage polyester powder-coat process applied on our dedicated paint lines. Variety of standard and custom finishes are available. All exposed materials are chromate pretreated to resist corrosion. Standard Matte White interior finish on reflectors.

ELECTRONICS

LED system features high brightness white Nichia LEDs. 3-step MacAdam Ellipse binning. Standard CRI: 80+. Higher CRI, R9 and custom LED configurations are available; consult factory. Variety of electronic 120V/277V and dimming drivers. LED module is 2 circuit with 2 drivers for multi circuit option as well as safety.

CONSTRUCTION

Extruded and machined 6063-T5 aluminum housing. Graphite gasket for optimal thermal management. Die-cast aluminum heat sink. Reflector made of spun .060" aluminum.

CODE COMPLIANCE

BAA compliant. ETL certified to meet US and Canadian standards. Suitable for dry or damp locations. Manufactured and tested to UL standards No. 1598/8750.

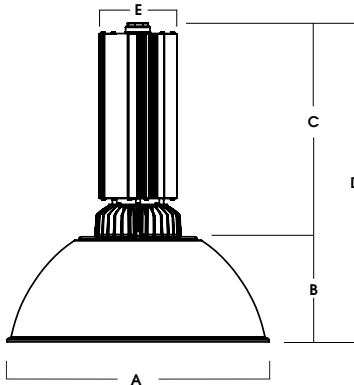

A	B	C	D	E
22.4	9.0	18.2	27.2	6.6
569.0 mm	228.6 mm	462.3 mm	690.9 mm	167.6 mm

Fixture Weight: 15.0 lbs

LUMENS / WATTAGE DATA				
PART NUMBER	SOURCE LUMENS ¹	DELIVERED LUMENS ²	SYSTEM WATTS	LPW
ALEXL22LX65L	6500	5684	60	95
ALEXL22LX100L	10000	8946	88	102
ALEXL22LX130L	13000	11996	117	103
ALEXL22LX140L	14000	12956	126	103

SERIES	LUMENS ¹	CCT	DRIVER / DIMMING ³	OPTIONS ⁴	MOUNTING ⁵	REFLECTOR	DIFFUSER OPTIONS	GUARD OPTION	FINISH ¹⁰
ALEXL22LX	65L 6500 Lm	27K 2700K	EX Electronic Driver, 120V/277V DS10X 10% 0-10V, 120V/277V DO10X 1% 0-10V, 120V/277V DO103 1% 0-10V, 347V	SAFETY OPTIONS FS Fusing 2CIR 2 Circuit SC1 Safety Cable SC2 Safety Cable Reflector to door	HM ⁶ Hang Straight AT ⁷ Hang Straight All Thread PM ⁸ Rigid Pendant CD ⁹ Cord / Cable Mount HC ⁹ Hook & Cord NM2 ⁹ 1/2" NPT Hub NM3 ⁹ 3/4" NPT Hub EMERGENCY BATTERY OPTIONS EMIT 7W Emergency Battery Test Switch EMCR 10W Canopy Mounted EM EMRM 7W Remote EM EMEN 7W Remote with Enclosure	AL22/MWI ⁹ Matte White Inside AL22/FCI Fixture Color Inside	TF3 - 6" Frosted Diffuser (CANNOT BE USED WITH DR OPTION) DOOR DOOR DR22A ⁹ 22" Spun Door BC22 22" Band Clamp LENSE LENS CNFR Conical Frosted CN Conical Lens DL Drop Lens FO White Optical Acrylic PP Prismatic Polycarbonate Clear PC Polycarbonate	WAG22 22" Wire Guard (CANNOT BE USED WITH DR OPTION)	MW ¹¹ Matte White MB ¹¹ Matte Black PT ¹¹ Platinum Silver CC Custom Color See Page 5 for Full Range of Color Options (83-90081)
	100L 10000 Lm	30K 3000K							
	130L 13000 Lm	35K 3500K							
	140L 14000 Lm	40K 4000K							

EXAMPLE: ALEXL22LX100L35KEX/HM36/AL22/MWI/MT

NOTES:

1 Nominal Source Lumens at 35K 2 Nominal Delivered Lumens at 35K with AL22, No Lens 3 Contact Factory for Additional Options 4 See Product Options Page For Details 5 See Mounting Page for Details on Components and Finishes 6 Specify Length in Inches: See Mounting Page for Available Lengths 7 Mounting Supplied by Others 8 Reflector Finished Matte White with Finish Color Out 9 Same Finish as Housing 10 See Color Page for More Options / Consult Factory for Special Finishes 11 Standard Finishes



PROJECT: _____
TYPE: _____



Dimensions and values shown are nominal. Spectrum Lighting continually works to improve products and reserves the right to make changes which may alter the performance or appearance of products.

22" ALUMINUM

EXL SERIES / FIXTURE OPTIONS



STANDARD FINISHES

MW
MATTE WHITE



MB
MATTE BLACK



PT
PLATINUM SILVER



MOUNTING TYPES

HM / AT / PM
HANG STRAIGHT / ALL THREAD / PENDANT

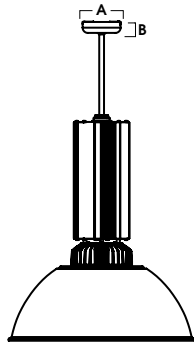

A	B
5.0	1.5
127 mm	38.1 mm

CD
CORD / CABLE MOUNT

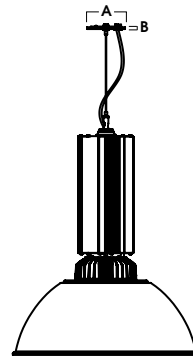

A	B
5.0	.25
63.5 mm	6.35 mm

HC
HOOK CORD

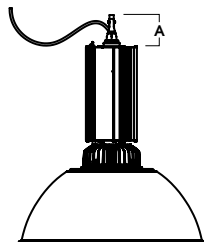

A
4.0
101.6 mm

NM
NO MOUNT

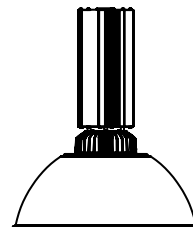

MOUNTING & ACCESSORIES

SOME OPTIONS NOT AVAILABLE ON ALL FIXTURES. CONSULT SPECIFICATION SHEETS. SEE INDIVIDUAL SPECIFICATION SHEETS OR CONSULT FACTORY FOR ADDITIONAL INFORMATION. NOTE: THIS IS TYPICAL OF RLM SPECIFICATION FOR MOUNTING. INDIVIDUAL FIXTURES OR PROJECTS MAY HAVE SPECIALIZED REQUIREMENTS.



ADDITIONS

FS - FUSING

Slow blow type fuse protects fixture against voltage surges. Factory installed.



LSP10 - SM - SURGE PROTECTOR

Surge protector absorbs transient electrical spikes and protects fixtures and electronics 120/277v. Re-sets after surge. Factory Installed.



SAFETY CABLE OPTIONS

SC1 - SAFETY CABLE

1/16" stainless steel safety cable for added support. Standard kit is 18" and double barrel locks are provided. Approved for California seismic requirements. Rated at 50 lbs.



SC2 - SAFETY CABLE

1/16" Stainless steel cable holds door to fixture



OPTIONS

DIFFUSER

TF3-6" Frosted Diffuser



DOOR

DR22A-22" Spun Door
BC22-22" Band Clamp

LENSES

CNFR-Conical Frosted Lens
CN-Conical Lens
DL-Drop Lens
FO-White Optical Acrylic
PP-Prismatic Polycarbonate
PC-Clear Polycarbonate







DR22A SHOWN WITH CN

GUARD OPTION

WAG22-22" Wire Guard

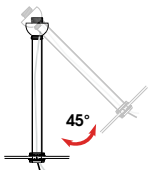
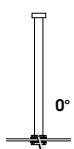
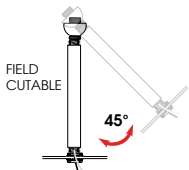
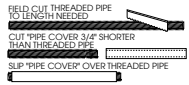

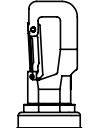
MOUNTING TYPES

<p>HM* HANG STRAIGHT 45° SWIVEL 5/8" OD STEM - 3/8" IP</p>  <p>ORDER: HM (Length) SPECIFY LENGTH: HM3 - 3" HM24 - 24" HM6 - 6" HM36 - 36" HM12 - 12" HM48 - 48" HM18 - 18" HM72 - 72" HMLC(XX) Custom Length (Specify in Inches)</p>	<p>PM* RIGID PENDANT MOUNT RIGID 5/8" OD STEM - 3/8" IP</p>  <p>ORDER: PM (Length) SPECIFY LENGTH: PM3 - 3" PM24 - 24" PM6 - 6" PM36 - 36" PM12 - 12" PM48 - 48" PM18 - 18" PM72 - 72" PMLC(XX) Custom Length (Specify in Inches)</p>	<p>AT** HANG STRAIGHT ALL THREAD 45° SWIVEL 5/8" OD STEM - 1/4" IP</p>  <p>ORDER: AT (Length) SPECIFY LENGTH: AT12 - 12" AT24 - 24" AT36 - 36"</p>  <p>FIELD CUT THREADED PIPE TO LENGTH NEEDED CUT PIPE COVER 3/4" SHORTER THAN THREADED PIPE SLIP PIPE COVER OVER THREADED PIPE</p>	<p>CD CORD / CABLE MOUNT SJ CORD WITH 1/16 SS CABLE</p>  <p>ORDER: CD (Length) SPECIFY LENGTH: CD36 - 36" CD72 - 72" CD144 - 144" CDLC(XX) Custom Length (Specify in Inches)</p>	<p>HC HOOK & CORD FOR INDEPENDENT MOUNTING</p>  <p>ORDER: HC (Length) SPECIFY LENGTH: HC36 - 36" HC72 - 72" HC144 - 144" HCLC(XX) Custom Length (Specify in Inches)</p>	<p>NMX 1/2" NPT Hub 3/4" NPT Hub FOR INDEPENDENT MOUNTING</p>  <p>ORDER: NMX (Length) SPECIFY LENGTH: NM2(12) - 12" Leads are Standard NM3(12) - 12" Leads are Standard NMXLC(XX) Custom Length (Specify in Inches)</p>
--	---	--	---	--	---

*MAXIMUM ONE PIECE STEM LENGTH IS 72". **MAXIMUM ONE PIECE STEM LENGTH IS 36". LONGER LENGTHS ARE POSSIBLE USING MULTIPLE STEMS AND COUPLERS.

EMERGENCY BATTERY OPTIONS

EMCR - LARGE DRIVER CANOPY FOR 10W EMERGENCY BATTERY

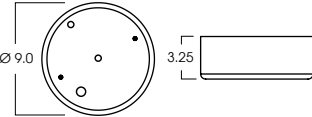

A	B	C
1.3	12.6	13.0

REMOTE EMERGENCY BATTERY OPTIONS

EMRM* - 7W REMOTE EMERGENCY BATTERY (60' MAX)

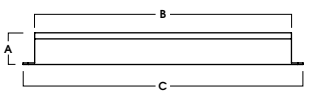

A	B	C
1.3	12.6	13.0

EMEN* - 7W REMOTE EMERGENCY BATTERY WITH ENCLOSURE (60' MAX)

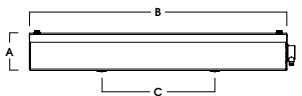

A	B	C
2.0	17.0	6.2

*OTHER EM BATTERY SIZES AVAILABLE. CONSULT FACTORY

22" ALUMINUM

EXL SERIES / PHOTOMETRIC DATA



ALxx22LEDLX

CANDLEPOWER CURVE	INTENSITY	ZONAL LUMENS	SINGLE UNIT: PERFORMANCE INITIAL FOOTCANDLES BASED ON IES BEAM ANGLE		MULTIPLE UNITS: PERFORMANCE 80/50/20% REFLECTANCES INITIAL FOOTCANDLES AND WATTS PER SQUARE FOOT								
	0.00°	0° - 10°	717	6%	Mounting Height AFF	FC at Center on Floor	Ceiling Height	Fixture Spacing	RCR 2		RCR 4		
	0.00°	6,928	0° - 20°	2,341	18%	10.0'	69 fc	22'	16'*	50	0.52	26	0.34
	20.00°	5,503	0° - 30°	4,726	36%	12.0'	48 fc	26'	18''*	32	0.33	37	0.48
	40.00°	4,344	0° - 40°	7,613	59%	14.0'	35 fc	32'	20''**	27	0.28	22	0.28
	60.00°	542	0° - 60°	12,120	93%	16.0'	27 fc	Delivered Illuminance Rating: (DIR)		96 FC per W/Sq. Ft.		78 FC per W/Sq. Ft.	
	80.00°	185	0° - 80°	12,902	99%	20.0'	17 fc	2' Suspension Length Square rooms used for multiple units: - RCR 2: Length & Width = Ceiling Ht. - 6.5' x 5.00 - RCR 4: Length & Width = Ceiling Ht. - 6.5' x 2.50					
	90.00°	4	0° - 90°	12,995	100%	24.0'	12 fc	* Average Footcandles at 2.5' Above Floor					
			Total	12,995	100%	28.0'	9 fc	** Exceeds spacing criteria by -2%					
						32.0'	7 fc	*** Exceeds spacing criteria by -25%					

Delivered Lumens: 12,995
Luminaire Watts: 126
LER: 103.13

CP at 0deg (Nadir): 6,928
CRI: 85

Lamp Multiplier: 65L x 0.47, 100L x 0.71, 130L x 0.93
CCT Multiplier: 40K x 1.03, 30K x 0.979, 27K x 0.959

COLOR OPTIONS - POWDER COAT PAINT FINISHES

NOTE: NO PRINTED IMAGE CAN EQUAL THE EXACT COLOR OF FINISH ON METAL.
SEE INDIVIDUAL SPECIFICATION SHEETS OR CONSULT FACTORY FOR ADDITIONAL INFORMATION.



STANDARD CORD / STEM / CANOPY FINISHES

FIXTURE COLOR	STANDARD CORD COLOR	STANDARD CANOPY / STEM COLOR
Matte White, Textured White	Matte White	Matte White
Gloss White	Matte White	Gloss White
Matte Black, Gloss Black, Textured Black	Matte Black	Matte Black
All Others	Matte Black	Same Color as Fixture
Custom Color	Contact Factory	Contact Factory

PAINT TIMES

TIER	COST	AVERAGE PAINT TIME*
Tier 1 - Standard Finishes	\$	⌚
Tier 2 - Typical Finishes	\$\$	⌚⌚
Custom Color	Contact Factory	Contact Factory

*CONTACT FACTORY FOR SPECIFIC PRODUCT LEAD TIMES

TIER 1 - STANDARD FINISHES



TIER 2 - TYPICAL FINISHES



CUSTOM COLOR FINISHES

CONTACT FACTORY

CC
Custom Color



*UNAVAILABLE FOR WET LOCATION