



22" PRISMATIC AF SERIES



PRAF22LX

APPLICATION

22" Arc Pendant evokes industrial age designs while using the latest LED technology for excellent general illumination. Prismatic refractor provides horizontal and vertical distribution. Laser cut decorative arm.

FEATURES

Extruded Fixture Housing (EXT). Single-stage optical system for smooth light distribution. LED module and driver designed for ease of maintenance and replacement. Post-lock refractor retention ring will absorb shocks and impacts. Optional safety cable. Variety of mounting methods.

FINISH

Multi-stage polyester powder-coat process applied on our dedicated paint lines. Variety of standard and custom finishes are available. All exposed materials are chromate pretreated to resist corrosion.

ELECTRONICS

LED system features high brightness white Nichia LEDs. 3-step MacAdam Ellipse binning. Standard CRI: 80+. Higher CRI, R9 and custom LED configurations are available; consult factory. Variety of electronic 120V/277V and dimming drivers. LED module is 2 circuit with 2 drivers for multicircuit option.

CONSTRUCTION

Extruded and machined 6063-T5 aluminum housing. Graphite gasket for optimal thermal management. Die-cast aluminum heat sink. Refractor made of cast UV stabilized acrylic. ARC pendant arms and deco ring are laser cut 5052 aluminum.

CODE COMPLIANCE

BAA compliant. ETL certified to meet US and Canadian standards. Suitable for dry or damp locations. Manufactured and tested to UL standards No. 1598/8750.

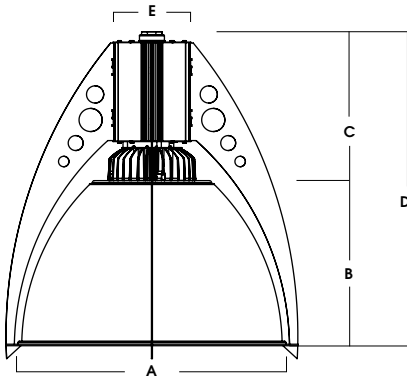

| A | B | C | D | E |
|------------------|------------------|------------------|------------------|-----------------|
| 24.4 619.8 mm | 12.3 312.4 mm | 10.6 269.2 mm | 22.9 581.7 mm | 6.5 165.1 mm |

| LUMENS / WATTAGE DATA | | | | |
|-----------------------|----------------------------|-------------------------------|--------------|-----|
| PART NUMBER | SOURCE LUMENS ¹ | DELIVERED LUMENS ² | SYSTEM WATTS | LPW |
| PRAF22LX65L | 6500 | 5697 | 59 | 97 |
| PRAF22LX100L | 10000 | 8545 | 88 | 97 |
| PRAF22LX130L | 13000 | 11304 | 117 | 97 |
| PRAF22LX140L | 14000 | 12174 | 126 | 97 |

| SERIES | LUMENS ¹ | CCT | DRIVER / DIMMING ² | OPTIONS ⁴ | MOUNTING ⁵ | REFRACTOR | DIFFUSER OPTION | TIER OPTIONS | FINISH ⁹ |
|----------|---------------------|-----------|---------------------------------|---|---|---|-------------------------|--|--|
| PRAF22LX | 65L 6500 Lm | 27K 2700K | EX Electronic Driver, 120V/277V | SAFETY OPTIONS FS Fusing 2CIR 2 Circuit SC1 Safety Cable SC2 Safety Cable Reflector to door | HM ⁶ Hang Straight AT ⁷ Hang Straight All Thread PM ⁸ Rigid Pendant CD ⁸ Cord/Cable Mount HC ⁸ Hook & Cord NM2 ⁸ 1/2" NPT Hub NM3 ⁸ 3/8" NPT Hub | DF22 22" Diffuse PR22 22" Clear OP22 22" Opal | TF3 6" Frosted Diffuser | AFPF Aluminum Fins w/ Decorative Perforations and 1-Metal Tier Ring AFSF Aluminum Decorative Arm with Slots and 1-Metal Tier Ring | MW ⁹ Matte White MB ⁹ Matte Black PT ⁹ Platinum Silver CC Custom Color |
| | 100L 10000 Lm | 30K 3000K | | | | | | | |
| | 130L 13000 Lm | 35K 3500K | | | | | | | |
| | 140L 14000 Lm | 40K 4000K | | | | | | | |
| | | | | | | | | | See Page 5 for Full Range of Color Options (83-90081) |

EXAMPLE: PRAF22LX100L35KEX/CD36/PR22/AFPF/MW

NOTES:
 1 Nominal Source Lumens at 35K 2 Nominal Delivered Lumens at 35K with PR22AFPFMW 3 Contact Factory for Additional Options 4 See Product Options Page For Details 5 See Mounting Page for Details on Components and Finishes 6 Specify Length in Inches: See Mounting Page for Available Lengths 7 Mounting Supplied by Others 8 See Color Page for More Options / Consult Factory for Special Finishes 9 Standard Finishes



PROJECT: _____
 TYPE: _____



Dimensions and values shown are nominal. Spectrum Lighting continually works to improve products and reserves the right to make changes which may alter the performance or appearance of products.

22" PRISMATIC

AF SERIES / FIXTURE OPTIONS



STANDARD FINISHES

MW
MATTE WHITE



MB
MATTE BLACK



PT
PLATINUM SILVER



DECORATIVE ARMS

AFPF
LASER CUT DECO ARM WITH HOLES

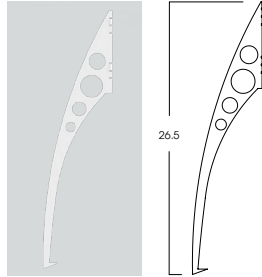

AFSF
LASER CUT DECO ARM WITH SLOTS

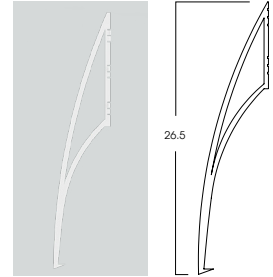

MOUNTING TYPES

HM / AT / PM
HANG STRAIGHT / ALL THREAD / PENDANT

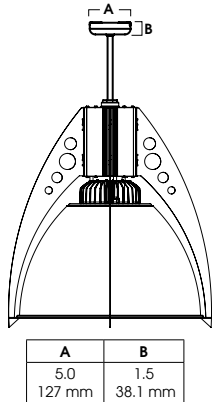

CD
CORD / CABLE MOUNT

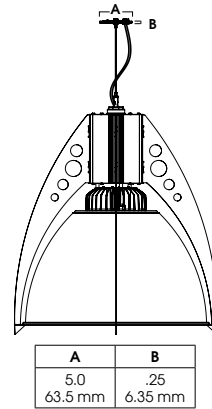

HC
HOOK CORD

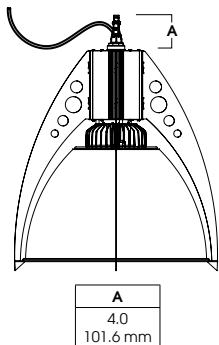

NM
NO MOUNT

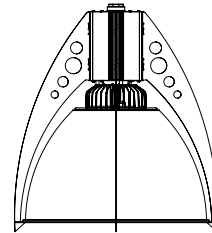



MOUNTING & ACCESSORIES

SOME OPTIONS NOT AVAILABLE ON ALL FIXTURES. CONSULT SPECIFICATION SHEETS. SEE INDIVIDUAL SPECIFICATION SHEETS OR CONSULT FACTORY FOR ADDITIONAL INFORMATION. NOTE: THIS IS TYPICAL OF RLM SPECIFICATION FOR MOUNTING. INDIVIDUAL FIXTURES OR PROJECTS MAY HAVE SPECIALIZED REQUIREMENTS.



ADDITIONS

| | |
|--|---|
| <p>FS - FUSING</p> <p>Slow blow type fuse protects fixture against voltage surges. Factory installed.</p>  | <p>LSP10 - SM - SURGE PROTECTOR</p> <p>Surge protector absorbs transient electrical spikes and protects fixtures and electronics 120/277v. Re-sets after surge. Factory Installed.</p>  |
|--|---|



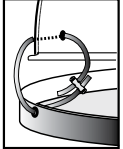

SAFETY CABLE OPTIONS

| | |
|--|---|
| <p>SC1 - SAFETY CABLE</p> <p>1/16" stainless steel safety cable for added support. Standard kit is 18" and double barrel locks are provided. Approved for California seismic requirements. Rated at 50 lbs.</p>  | <p>SC2 - SAFETY CABLE</p> <p>1/16" Stainless steel cable holds door to fixture</p>  |
|--|---|

OPTIONS

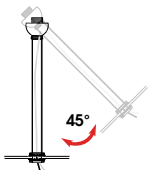
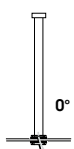
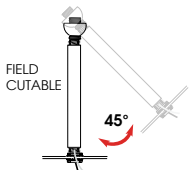
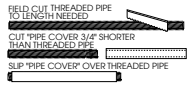
| | |
|--|--|
| <p>DIFFUSER</p> <p>TF3-6" Frosted Diffuser</p>  | <p>TIER OPTIONS</p> <p>AFFP-Aluminum Fins w/ Decorative Perforations and 1-Metal Tier Ring AFSF-Aluminum Decorative Arm with Slots and 1-Metal Tier Ring</p> |
|--|--|

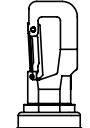
MOUNTING TYPES

| | | | | | |
|---|--|---|---|--|--|
| <p>HM* HANG STRAIGHT 45° SWIVEL 5/8" OD STEM - 3/8" IP</p>  <p>ORDER: HM (Length) SPECIFY LENGTH: HM3 - 3" HM24 - 24" HM6 - 6" HM36 - 36" HM12 - 12" HM48 - 48" HM18 - 18" HM72 - 72" HMLC(XX) Custom Length (Specify in Inches)</p> | <p>PM* RIGID PENDANT MOUNT RIGID 5/8" OD STEM - 3/8" IP</p>  <p>ORDER: PM (Length) SPECIFY LENGTH: PM3 - 3" PM24 - 24" PM6 - 6" PM36 - 36" PM12 - 12" PM48 - 48" PM18 - 18" PM72 - 72" PMLC(XX) Custom Length (Specify in Inches)</p> | <p>AT** HANG STRAIGHT ALL THREAD 45° SWIVEL 5/8" OD STEM - 1/4" IP</p>  <p>ORDER: AT (Length) SPECIFY LENGTH: AT12 - 12" AT24 - 24" AT36 - 36"</p>  | <p>CD CORD / CABLE MOUNT SJ CORD WITH 1/16 SS CABLE</p>  <p>ORDER: CD (Length) SPECIFY LENGTH: CD36 - 36" CD72 - 72" CD144 - 144" CDLC(XX) Custom Length (Specify in Inches)</p> | <p>HC HOOK & CORD FOR INDEPENDENT MOUNTING</p>  <p>ORDER: HC (Length) SPECIFY LENGTH: HC36 - 36" HC72 - 72" HC144 - 144" HCLC(XX) Custom Length (Specify in Inches)</p> | <p>NMX 1/2" NPT Hub 3/4" NPT Hub FOR INDEPENDENT MOUNTING</p>  <p>ORDER: NMX (Length) SPECIFY LENGTH: NM2(12) - 12" Leads are Standard NM3(12) - 12" Leads are Standard NMXLC(XX) Custom Length (Specify in Inches)</p> |
|---|--|---|---|--|--|

*MAXIMUM ONE PIECE STEM LENGTH IS 72". **MAXIMUM ONE PIECE STEM LENGTH IS 36". LONGER LENGTHS ARE POSSIBLE USING MULTIPLE STEMS AND COUPLERS.

EMERGENCY BATTERY OPTIONS

EMCR - LARGE DRIVER CANOPY FOR 10W EMERGENCY BATTERY

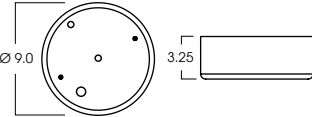

| | | |
|-----|------|------|
| A | B | C |
| 1.3 | 12.6 | 13.0 |

REMOTE EMERGENCY BATTERY OPTIONS

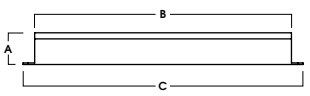
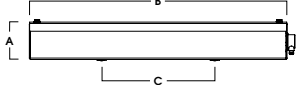
| | | | | | | | | | | | | | |
|---|------|------|---|-----|------|------|--|---|---|---|-----|------|-----|
| <p>EMRM* - 7W REMOTE EMERGENCY BATTERY (60' MAX)</p>  <table border="1"> <tr> <td>A</td> <td>B</td> <td>C</td> </tr> <tr> <td>1.3</td> <td>12.6</td> <td>13.0</td> </tr> </table> | A | B | C | 1.3 | 12.6 | 13.0 | <p>EMEN* - 7W REMOTE EMERGENCY BATTERY WITH ENCLOSURE (60' MAX)</p>  <table border="1"> <tr> <td>A</td> <td>B</td> <td>C</td> </tr> <tr> <td>2.0</td> <td>17.0</td> <td>6.2</td> </tr> </table> | A | B | C | 2.0 | 17.0 | 6.2 |
| A | B | C | | | | | | | | | | | |
| 1.3 | 12.6 | 13.0 | | | | | | | | | | | |
| A | B | C | | | | | | | | | | | |
| 2.0 | 17.0 | 6.2 | | | | | | | | | | | |

*OTHER EM BATTERY SIZES AVAILABLE. CONSULT FACTORY

22" PRISMATIC

AF SERIES / PHOTOMETRIC DATA



PRxxx22LX-140L-35K-EX-DF22

| CANDLEPOWER CURVE | INTENSITY | ZONAL LUMENS | SINGLE UNIT: PERFORMANCE | | MULTIPLE UNITS: PERFORMANCE | | | | | | | | |
|-------------------|---|--------------|--|--------|---|--------------------------|-------------------|---|---------|----------------------|-----------|---------------------|-----------|
| | | | INITIAL FOOTCANDLES BASED ON IES BEAM ANGLE | | 80/50/20% REFLECTANCES INITIAL FOOTCANDLES AND WATTS PER SQUARE FOOT | | | | | | | | |
| | 0.00° | | | | Mounting Height AFF | FC at Center on Floor | Ceiling Height | Fixture Spacing | RCR 2 | | RCR 4 | | |
| | 0.00° | 7,914 | 0° - 10° | 776 | | | | | 5% | FC + | W/Sq. Ft. | FC + | W/Sq. Ft. |
| | 20.00° | 7,314 | 0° - 20° | 2,974 | 21% | 10.0' | 79 fc | 22' | 20' * | 33 | 0.34 | 28 | 0.34 |
| | 40.00° | 2,734 | 0° - 30° | 6,050 | 43% | 12.0' | 55 fc | 26' | 22' ** | 21 | 0.21 | 18 | 0.21 |
| | 60.00° | 856 | 0° - 40° | 9,018 | 63% | 14.0' | 40 fc | 32' | 24' *** | 19 | 0.19 | 23 | 0.28 |
| | 80.00° | 486 | 0° - 60° | 10,965 | 77% | 16.0' | 31 fc | Delivered Illuminance Rating: (DIR) | | 100 FC per W/Sq. Ft. | | 83 FC per W/Sq. Ft. | |
| | 90.00° | 352 | 0° - 80° | 12,315 | 87% | 20.0' | 20 fc | 2' Suspension Length Square rooms used for multiple units: | | | | | |
| | 100.00° | 278 | 0° - 90° | 12,767 | 90% | 24.0' | 14 fc | - RCR 2: Length & Width = Ceiling Ht. - 6.5' x 5.00 | | | | | |
| | 110.00° | 229 | Total | 14,229 | 100% | 28.0' | 10 fc | - RCR 4: Length & Width = Ceiling Ht. - 6.5' x 2.50 | | | | | |
| | 120.00° | 201 | | | | 32.0' | 8 fc | * Average Footcandles at 2.5' Above Floor | | | | | |
| | 140.00° | 200 | | | | | | ** Exceeds spacing criteria by 14% | | | | | |
| | 160.00° | 225 | | | | | | *** Exceeds spacing criteria by -0% | | | | | |
| | 180.00° | 216 | | | | | | *** Exceeds spacing criteria by -17% | | | | | |
| | Delivered Lumens: 14,229 Luminaire Watts: 126 LER: 112.93 | | CP at 0deg (Nadir): 7,914 CRI: 85+ | | Lamp Multiplier: 65L x 0.47, 100L x 0.71, 130L x 0.93 CCT Multiplier: 40K x 1.03, 30K x 0.979, 27K x 0.959 | | | | | | | | |

PRxxx22LEDLX-140L-35K-E1-XXXX-PR22

| CANDLEPOWER CURVE | INTENSITY | ZONAL LUMENS | SINGLE UNIT: PERFORMANCE | | MULTIPLE UNITS: PERFORMANCE | | | | | | | | |
|-------------------|--|--------------|--|--------|---|--------------------------|-------------------|---|---------|---------------------|-----------|---------------------|-----------|
| | | | INITIAL FOOTCANDLES BASED ON IES BEAM ANGLE | | 80/50/20% REFLECTANCES INITIAL FOOTCANDLES AND WATTS PER SQUARE FOOT | | | | | | | | |
| | 0.00° | | | | Mounting Height AFF | FC at Center on Floor | Ceiling Height | Fixture Spacing | RCR 2 | | RCR 4 | | |
| | 0.00° | 9,341 | 0° - 10° | 1,033 | | | | | 8% | FC + | W/Sq. Ft. | FC + | W/Sq. Ft. |
| | 20.00° | 10,049 | 0° - 20° | 4,060 | 33% | 10.0' | 93 fc | 22' | 16' * | 49 | 0.52 | 27 | 0.34 |
| | 40.00° | 1,737 | 0° - 30° | 7,872 | 65% | 12.0' | 65 fc | 26' | 18' ** | 31 | 0.33 | 39 | 0.48 |
| | 60.00° | 221 | 0° - 40° | 10,281 | 84% | 14.0' | 48 fc | 32' | 20' *** | 26 | 0.28 | 23 | 0.28 |
| | 80.00° | 107 | 0° - 60° | 11,264 | 92% | 16.0' | 36 fc | Delivered Illuminance Rating: (DIR) | | 93 FC per W/Sq. Ft. | | 81 FC per W/Sq. Ft. | |
| | 90.00° | 55 | 0° - 80° | 11,542 | 95% | 20.0' | 23 fc | 2' Suspension Length Square rooms used for multiple units: | | | | | |
| | 100.00° | 55 | 0° - 90° | 11,621 | 95% | 24.0' | 16 fc | - RCR 2: Length & Width = Ceiling Ht. - 6.5' x 5.00 | | | | | |
| | 110.00° | 73 | Total | 12,193 | 100% | 28.0' | 12 fc | - RCR 4: Length & Width = Ceiling Ht. - 6.5' x 2.50 | | | | | |
| | 120.00° | 71 | | | | 32.0' | 9 fc | * Average Footcandles at 2.5' Above Floor | | | | | |
| | 140.00° | 121 | | | | | | ** Exceeds spacing criteria by -4% | | | | | |
| | 160.00° | 172 | | | | | | *** Exceeds spacing criteria by -14% | | | | | |
| | 180.00° | 206 | | | | | | *** Exceeds spacing criteria by -27% | | | | | |
| | Delivered Lumens: 12,193 Luminaire Watts: 126 LER: 96.77 | | CP at 0deg (Nadir): 9,341 CRI: 85 | | Lamp Multiplier: 65L x 0.67, 100L x 1, 130L x 1.32, 140L x 1.42 CCT Multiplier: 40K x 1.03, 30K x 0.98, 27K x 0.96 | | | | | | | | |

COLOR OPTIONS - POWDER COAT PAINT FINISHES

NOTE: NO PRINTED IMAGE CAN EQUAL THE EXACT COLOR OF FINISH ON METAL.
SEE INDIVIDUAL SPECIFICATION SHEETS OR CONSULT FACTORY FOR ADDITIONAL INFORMATION.



STANDARD CORD / STEM / CANOPY FINISHES

| FIXTURE COLOR | STANDARD CORD COLOR | STANDARD CANOPY / STEM COLOR |
|--|---------------------|------------------------------|
| Matte White, Textured White | Matte White | Matte White |
| Gloss White | Matte White | Gloss White |
| Matte Black, Gloss Black, Textured Black | Matte Black | Matte Black |
| All Others | Matte Black | Same Color as Fixture |
| Custom Color | Contact Factory | Contact Factory |

PAINT TIMES

| TIER | COST | AVERAGE PAINT TIME* |
|----------------------------|-----------------|---------------------|
| Tier 1 - Standard Finishes | \$ | ⌚ |
| Tier 2 - Typical Finishes | \$\$ | ⌚⌚ |
| Custom Color | Contact Factory | Contact Factory |

*CONTACT FACTORY FOR SPECIFIC PRODUCT LEAD TIMES

TIER 1 - STANDARD FINISHES



TIER 2 - TYPICAL FINISHES



CUSTOM COLOR FINISHES

CONTACT FACTORY

CC
Custom Color



*UNAVAILABLE FOR WET LOCATION