

4" SQUARE LED DOWNLIGHT TUNABLE COLOR (HUE) LU SERIES / 1800 LUMENS MAX LED

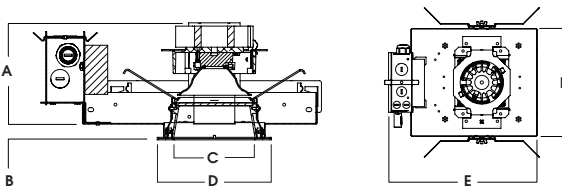
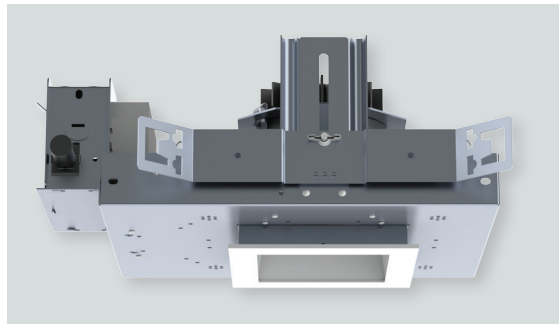
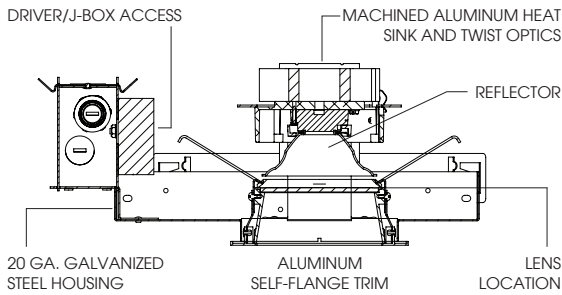

A	B	C	D	E	F
6.1 154.9 mm	.625 15.2 mm	4.0 101.6 mm	5.4 137.2 mm	14.7 373.4 mm	9.5 241.3 mm

SDFO4LEDLU - TRIM FLANGE / NON IC RATED

APPLICATION

4" Square LU LED downlight platform with Tunable color (HUE) LED system. System can be programmed for scenes or set for manual control. Adjusts to over 300,000 colors as well as 1600K-6000K white light.

FEATURES

Two-stage optical system for smooth light distribution and focus control. Quick change LED module with interchangeable optics for job site adjustment and fixture maintenance. Shallow plenum design. Tool-less driver and j-box access. Posi-lock trim retention torsion springs. Integral 0.625" collar with deep ceiling option for up to 2" thick ceiling (PR).

TRIM FINISH

A variety of powdercoat colors are available; flange will have matching finish. Semi-Diffuse and Haze Anodized trim will have Matte White Flange.

ELECTRONICS

LED system features LED module with proprietary Tunable color (HUE) technology that provides consistent, stable color with CCT control of +/- 100K over life of the light engine. Base CRI is 90 with <2 MacAdam Ellipse binning. Variety of dimming controls (by Others).

CONSTRUCTION

Housing/frame constructed of #20 ga. galvanized steel to resist corrosion. Self-flanged one piece trim high purity aluminum and finished to specification.

CODE COMPLIANCE

ARRA Compliant. Non-IC rated. ETL listed for damp locations. Optional Wet location. Manufactured and tested to UL standards No. 1598/8750.

WATTAGE TO LUMENS UPDATE			
CURRENT PART NUMBER EXAMPLE	PREVIOUS PART NUMBER EXAMPLE	SOURCE LUMENS ¹	SYSTEM WATTS
SDFO4LEDLU12L	SDFO4LEDLU11W	1250	20
SDFO4LEDLU14L	N/A	1400	25
SDFO4LEDLU16L	SDFO4LEDLU15W	1600	32
SDFO4LEDLU18L	SDFO4LEDLU20W	1800	32

RECESSED HOUSING SPECIFICATION

SERIES	LUMENS ¹	CCT / HUE	BEAM	CONTROL / VOLTAGE ²	OPTIONS
SDFO4LEDLU	12L 1250 Lm	40CMX 40K-16K	ND 20°	DU ³ 1% 0-10V Dimming DL3E ³ ECO System Dimming DMX ³ DMX Control Dimming BT ³ Bluetooth Control Dimming	1 BH27 ⁴ 27" Flat Stock Hangers 2 H12 Expandable Bar Hangers, 12" - 24" H06 Expandable Bar Hangers, 6" - 12" CB24 C-Channel Bars EB Black Housing PR ⁵ Deep Ceiling Extension REMLU ³ Remote Control
	14L 1400 Lm	60CMX 60K-27K	MD 30°		
	16L 1600 Lm		WD 40°		
	18L 1800 Lm		XW 50°		

LED TRIM SPECIFICATION

TRIM / FINISH ⁶	TRIM OPTIONS ¹⁰
SD4F ⁷ MW ⁸ Matte White	SOX ¹¹ Micro Prism Solite™ Lens
MB Matte Black	PGX Prismatic Glass Lens
SG ⁹ Semi-Diffuse	GLX Clear Glass Lens
HZ ⁹ Haze Full Diffuse	FGX Frosted Glass Lens
PT Platinum	
BZ Bronze	
CH Charcoal	SOW Micro Prism Solite™ Lens Wet Location
AS Anodic Sapphire	PGW Prismatic Glass Lens Wet Location
AM Anodic Malachite	SN Sun Gold
SN Sun Gold	CO Copper Metallic
CO Copper Metallic	GH Graphite
GH Graphite	AMB Anti Microbial Finish
AMB Anti Microbial Finish	CC Custom Color
CC Custom Color	FGW Frosted Glass Lens Wet Location

EXAMPLE: SDFO4LEDLU12L40CMXMDDMX1H12REMLU/SD4FMWSOX

NOTES:

1 Nominal Source Lumens 2 Contact Factory for Additional Options 3 Refer to CMX Controls Page 4 Standard Bar Hangers 5 Contact Factory 6 Contact Factory for Special Finishes 7 "F" Indicates Self-Flange Trim 8 Standard Finish 9 Anodized Reflector with Matte White Flange 10 Consult Factory for Special Lenses/Louvers 11 Standard Lens

Dimensions shown are nominal. Spectrum Lighting is continually improving products and reserves the right to make changes that will not alter performance or appearance with or without written notice.



PROJECT:	TYPE:
CAT. NO.:	



RECESSED CTM OPTIONS



DU1 / DU2 - Fixture can be operated by the following 3 methods (Does Not Require DCA).

1. Use with REMLU option for wireless control of dimming and color tuning. (See Figure 3)
2. Use with 0-10V controller and REMLU option for dimming control and presetting color levels with REMLU. (See Figure 4)
3. Use with 0-10V controller, plus CCT controller & REMLU option for separate dimming control, separate color tuning control & presetting color levels with REMLU. (See Figure 5 & 5B)

DL3E1 / DL3E2 - For control of dimming and color tuning with Eco System controller (Supplied by Lutron) Fixture supplied with DCA¹. (See Figure 1)

DMX1 / DMX2 - For control of dimming and color tuning with minimum 4 channel DMX controller (Supplied by Others) Fixture supplied with DCA¹. (See Figure 2 & 2B)

BT1 / BT2 - For control of dimming and color tuning with Bluetooth app (IOS Only) (Download by Others) Fixture supplied with DCA¹. (See Figure 2)

REMLU - is a remote wireless commissioning tool that allows complete control of fixture's Dimming, Color Saturation and Hue. Operates on Zigbee Platform @ 2.4GHz band. Maximum of 60 fixtures can be controlled with 5 separate present lighting scenes. Refer to installation instructions for wiring diagrams and operations.

Consult Factory for additional questions and information.

NOTES:

¹ DCA - Is a digital Control adapter which enables fixtures powered by standard lighting protocols to be converted to a digital link.

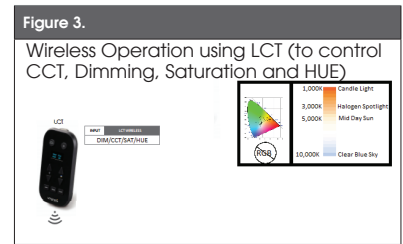
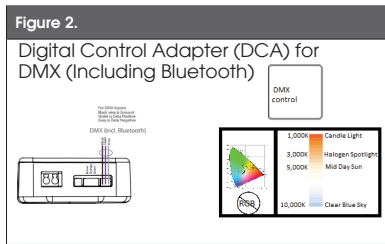
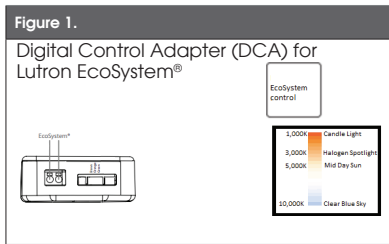

**Requires araya Tunable Color iOS APP

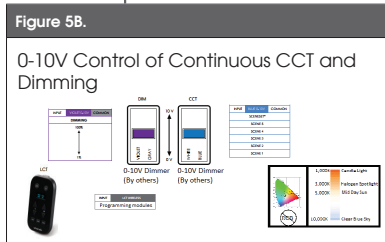
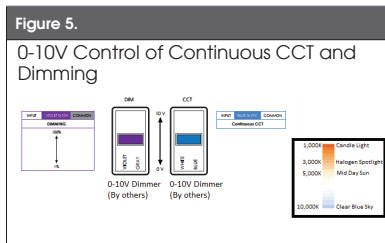
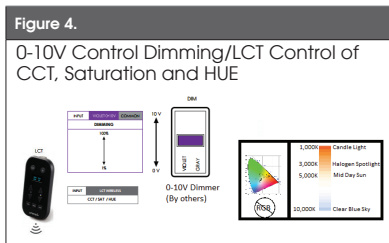
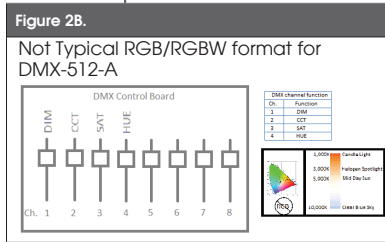

Dimensions shown are nominal. Spectrum Lighting is continually improving products and reserves the right to make changes that will not alter performance or appearance with or without written notice.



PROJECT:	TYPE:
CAT. NO.:	

