



1MR SHOWN

12" Low/Mid Bay 5500 Lm Glass Refractor



GPX12GV

APPLICATION

Lumen Max GV Series cast refractive performance pendant for low and mid-bay applications. Solid cast glass refractor provides horizontal and vertical distribution. Decorative support arms and lower parts add visual appeal.

FEATURES

Extruded Fixture Housing (EXT) features a clean and modern design. Single-stage optical system for smooth light distribution. LED module and driver designed for ease of maintenance and replacement. Optional safety cable. Variety of optical lenses and mounting methods.

FINISH

Multi-stage polyester powder-coat process applied on our dedicated paint lines. A wide variety of standard and custom finishes are available. All exposed materials are chromate pretreated to resist corrosion.

ELECTRONICS

GV LED system features high brightness white Samsung LED's. 3-step MacAdam Ellipse binning. Standard CRI: 80/90. Custom LED configurations are available, consult factory. Variety of electronic 120V/277V and dimming drivers.

CONSTRUCTION

Extruded and machined 6063-T5 aluminum housing. Graphite gasket for optimal thermal management. Die-cast aluminum heat sink. Refractor made of cast glass.

CODE COMPLIANCE

BAA compliant. ETL certified to meet US and Canadian standards. Suitable for dry or damp locations. Manufactured and tested to UL standards No. 1598/8750.

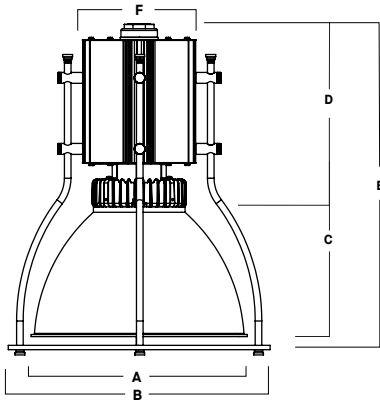

A	B	C	D	E	F
12.4	15.0	7.4	10.5	18.7	6.5
315.0 mm	381.0 mm	188.0 mm	266.7 mm	475.0 mm	165.1 mm

Fixture Weight: 18.26 lbs

LUMENS / WATTAGE DATA		
PART NUMBER	SOURCE LUMENS ¹	SYSTEM WATTS
GPX12GV15L	1500	10
GPX12GV27L	2700	18
GPX12GV37L	3700	26
GPX12GV55L	5500	39

¹ Nominal Source Lumens at 35K

SERIES	LUMENS ¹	CCT	DRIVER / DIMMING ²	OPTIONS ³	MOUNTING ⁴	REFRACTOR	TIER OPTIONS	FINISH ¹⁰	MOUNTING OPTION ¹²
GPX12GV	15L 1500 Lm	80 CRI	EX Electronic Driver, 120V/277V DS10X 10% 0-10V, 120V/277V DO10X 1% 0-10V, 120V/277V	FS Fusing SC1 Safety Cable	HM ⁵ Hang Straight PM ⁵ Rigid Pendant CD ⁵ Cord / Cable Mount HC ^{5/6/7} Hook & Cord NM2 ^{6/7/8} 1/2" NPT Hub NM3 ^{6/7/8} 3/4" NPT Hub	GPX12 12" Glass	CFG Center Frosted Glass Tier FGR Frosted Glass Ring 1MR ⁹ Single Metal Ring	MW ¹¹ Matte White MB ¹¹ Matte Black PT ¹¹ Platinum Silver CC Custom Color	FCHMA Field Cuttable Mounting Kit for Hang Mount Fixtures
	27L 2700 Lm	27K 2700K 30K 3000K 35K 3500K 40K 4000K 50K 5000K							
	37L 3700 Lm								
	55L 5500 Lm								

EXAMPLE: GPX12GV15L27KEX/HM36/GPX12/CFG/PT

NOTES:
¹ Nominal Source Lumens at 35K ² Contact Factory for Additional Options ³ See Product Options Page for Details ⁴ See Mounting Page for Details on Components and Finishes ⁵ Specify Length in Inches: See Mounting Page for Available Lengths
⁶ Mounting Supplied by Others ⁷ Not Available with EMCR ⁸ 12" Leads Unless Specified ⁹ Same Finish as Housing ¹⁰ Reference Color Sheet Located on Product Webpage for Full List of Available Colors ¹¹ Standard Finishes ¹² Field Cuttable Mounting Kit only Available with HM Stem



PROJECT: _____
 QUANTITY: _____ TYPE: _____



12" GLASS

TECH SERIES / FIXTURE OPTIONS



STANDARD FINISHES

MW
MATTE WHITE



MB
MATTE BLACK



PT
PLATINUM SILVER



DECO-TIER OPTIONS

1MR
SINGLE METAL RING



CFG
CENTERED FROSTED GLASS



FGR
FROSTED GLASS RING



MOUNTING TYPES

HM / PM
HANG STRAIGHT / PENDANT



GPX12GV SHOWN WITH PM

CD
CORD / CABLE MOUNT



GPX12GV SHOWN WITH CD

HC
HOOK CORD



GPX12GV SHOWN WITH HC

NM
NO MOUNT



GPX12GV SHOWN WITH NM



MOUNTING & ACCESSORIES

SOME OPTIONS NOT AVAILABLE ON ALL FIXTURES. CONSULT SPECIFICATION SHEETS. SEE INDIVIDUAL SPECIFICATION SHEETS OR CONSULT FACTORY FOR ADDITIONAL INFORMATION. NOTE: THIS IS TYPICAL OF RLM SPECIFICATION FOR MOUNTING. INDIVIDUAL FIXTURES OR PROJECTS MAY HAVE SPECIALIZED REQUIREMENTS.



ADDITIONS

FS - Fusing

Slow blow type fuse protects fixture against voltage surges. Factory installed.







SAFETY CABLE OPTIONS

SC1 - Safety Cable

1/16" stainless steel safety cable for added support. Standard kit is 18" and double barrel locks are provided. Approved for California seismic requirements. Rated at 50 lbs.

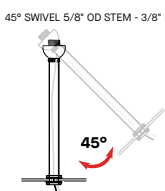
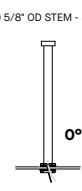

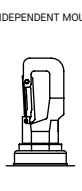
MOUNTING TYPES

<p>HM* - Hang Straight</p> <p>45° SWIVEL 5/8" OD STEM - 3/8" IP</p>  <p>ORDER: HM (Length) SPECIFY LENGTH:</p> <p>HM3 - 3" HM24 - 24" HM6 - 6" HM36 - 36" HM12 - 12" HM48 - 48" HM18 - 18" HM72 - 72" HMLC(XX) Custom Length (Specify in Inches)</p> <p>TO TRIM HM STEM IN FIELD ORDER FCHMA KIT.</p>	<p>PM* - Rigid Pendant Mount</p> <p>RIGID 5/8" OD STEM - 3/8" IP</p>  <p>ORDER: PM (Length) SPECIFY LENGTH:</p> <p>PM3 - 3" PM24 - 24" PM6 - 6" PM36 - 36" PM12 - 12" PM48 - 48" PM18 - 18" PM72 - 72" PMLC(XX) Custom Length (Specify in Inches)</p>	<p>CD - Cord / Cable Mount</p> <p>SJ CORD WITH 1/16 SS CABLE</p>  <p>ORDER: CD (Length) SPECIFY LENGTH:</p> <p>CD36 - 36" CD72 - 72" CD144 - 144" CDLC(XX) Custom Length (Specify in Inches)</p>	<p>HC - Hook & Cord</p> <p>FOR INDEPENDENT MOUNTING</p>  <p>ORDER: HC (Length) SPECIFY LENGTH:</p> <p>HC36 - 36" HC72 - 72" HC144 - 144" HCLC(XX) Custom Length (Specify in Inches)</p>	<p>NM2 - 1/2" NPT Hub NM3 - 3/4" NPT Hub FOR INDEPENDENT MOUNTING</p>  <p>ORDER: NMX (Length) SPECIFY LENGTH:</p> <p>NM2(12) - 12" Leads are Standard NM3(12) - 12" Leads are Standard NMXLC(XX) Custom Length (Specify in Inches)</p>
<p>*MAXIMUM ONE PIECE STEM LENGTH IS 72". LONGER LENGTHS ARE POSSIBLE USING MULTIPLE STEMS AND COUPLERS.</p> 				

MOUNTING OPTION

FCHMA - Field Cuttable Mounting Kit For Hang Mount Fixtures



EMERGENCY BATTERY OPTIONS

EMCR - Large Driver Canopy For 10W Emergency Battery

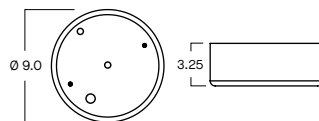

REMOTE EMERGENCY BATTERY OPTIONS

EMRM* - 7W Remote Emergency Battery (50' Max)

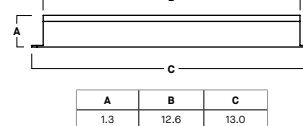

EMEN* - 7W Remote Emergency Battery with Enclosure (50' Max)

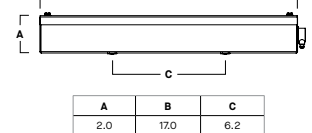

*OTHER EM BATTERY SIZES AVAILABLE. CONSULT FACTORY

