



# 16" ALUMINUM EXL SERIES



## ALEXL16LX

### APPLICATION

16" Lumen Max LX series performance pendant for low, mid-bay and high-bay applications. Aluminum reflector designed for maximum downlight.

### FEATURES

Extruded Fixture Housing (EXL) designed for Integral EM features a clean and modern design. Single-stage optical system for smooth light distribution. LED module and driver designed for ease of maintenance and replacement. Posi-lock reflector retention ring will absorb shocks and impact. Optional safety cable. Variety of optical lenses and mounting methods.

### FINISH

Multi-stage polyester powder-coat process applied on our dedicated paint lines. Variety of standard and custom finishes are available. All exposed materials are chromate pretreated to resist corrosion. Standard Matte White interior finish on reflectors.

### ELECTRONICS

LED system features high brightness white Nichia LEDs. 3-step MacAdam Ellipse binning. Standard CRI: 80+. Higher CRI, R9 and custom LED configurations are available; consult factory. Variety of electronic 120V/277V and dimming drivers. LED module is 2 circuit with 2 drivers for multi circuit option as well as safety.

### CONSTRUCTION

Extruded and machined 6063-T5 aluminum housing. Graphite gasket for optimal thermal management. Die-cast aluminum heat sink. Reflector made of spun .060" aluminum.

### CODE COMPLIANCE

BAA compliant. ETL certified to meet US and Canadian standards. Suitable for dry or damp locations. Manufactured and tested to UL standards No. 1598/8750.

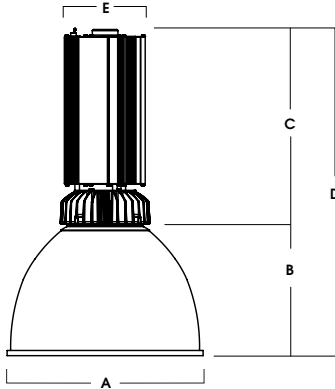

A	B	C	D	E
16.0	10.4	18.2	28.6	6.6
406.4 mm	264.2 mm	462.3 mm	726.4 mm	167.6 mm

Fixture Weight: 12.0 lbs

LUMENS / WATTAGE DATA				
PART NUMBER	SOURCE LUMENS <sup>1</sup>	DELIVERED LUMENS <sup>2</sup>	SYSTEM WATTS	LPW
ALEXL16LX65L	6500	5495	56.2	98
ALEXL16LX100L	10000	8243	81.06	102
ALEXL16LX130L	13000	10844	103.89	104
ALEXL16LX140L	14000	11677	111.89	104

SERIES	LUMENS <sup>1</sup>	CCT	DRIVER / DIMMING <sup>3</sup>	OPTIONS <sup>4</sup>	MOUNTING <sup>5</sup>	REFLECTOR	DIFFUSER OPTIONS	GUARD OPTION	FINISH <sup>10</sup>
ALEXL16LX	65L 6500 Lm	27K 2700K	EX Electronic Driver, 120V/277V DS10X 10%, 0-10V, 120V/277V DO10X 1%, 0-10V, 120V/277V DO103 1%, 0-10V, 347V	SAFETY OPTIONS FS Fusing 2CIR 2 Circuit SC1 Safety Cable SC2 Safety Cable Reflector to door	HM <sup>6</sup> Hang Straight AT <sup>6</sup> Hang Straight All Thread PM <sup>6</sup> Rigid Pendant CD <sup>6</sup> Cord / Cable Mount HC <sup>6</sup> Hook & Cord NM2 <sup>7</sup> 1/2" NPT Hub NM3 <sup>7</sup> 3/8" NPT Hub EMERGENCY BATTERY OPTIONS EMIT 7W Emergency Battery Test Switch EMCR 10W Canopy Mounted EM EMRM 7W Remote EM EMEN 7W Remote with Enclosure	AL16/MW <sup>8</sup> Matte White AL16/FCI Inside Fixture Color Inside	TF3 - 6" Frosted Diffuser (CANNOT BE USED WITH DR OPTION) DOOR DR16D <sup>9</sup> 16" Spun Door LENS CNFR Conical Frosted Lens CN Conical Lens DL Drop Lens FO White Optical Acrylic PP Prismatic Polycarbonate PC Clear Polycarbonate	WAG16 16" Wire Guard (CANNOT BE USED WITH DR OPTION)	MW <sup>11</sup> Matte White MB <sup>11</sup> Matte Black PT <sup>11</sup> Platinum Silver CC Custom Color  See Page 7 for Full Range of Color Options (83-90081)
	100L 10000 Lm	30K 3000K							
	130L 13000 Lm	35K 3500K							
	140L 14000 Lm	40K 4000K							

**EXAMPLE:** ALEXL16LX100L35KEX/HM36/AL16/MWI/MW

**NOTES:**  
 1 Nominal Source Lumens at 35K 2 Nominal Delivered Lumens at 35K with AL16, No Lens 3 Contact Factory for Additional Options 4 See Product Options Page For Details 5 See Mounting Page for Details on Components and Finishes 6 Specify Length in Inches: See Mounting Page for Available Lengths 7 Mounting Supplied by Others 8 Reflector Finished Matte White with Finish Color Out 9 Same Finish as Housing 10 See Color Page for More Options / Consult Factory for Special Finishes 11 Standard Finishes



PROJECT: \_\_\_\_\_  
 TYPE: \_\_\_\_\_



Dimensions and values shown are nominal. Spectrum Lighting continually works to improve products and reserves the right to make changes which may alter the performance or appearance of products.

# 16" ALUMINUM

## EXL SERIES / FIXTURE OPTIONS



### STANDARD FINISHES

**MW**  
MATTE WHITE



**MB**  
MATTE BLACK



**PT**  
PLATINUM SILVER



### MOUNTING TYPES

**HM / AT / PM**  
HANG STRAIGHT / ALL THREAD / PENDANT

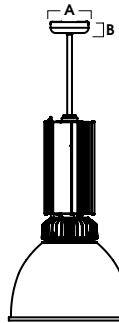

A	B
5.0	1.5
127 mm	38.1 mm

**CD**  
CORD / CABLE MOUNT

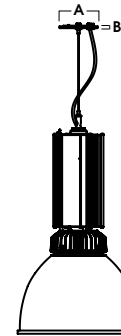

A	B
5.0	.25
63.5 mm	6.35 mm

**HC**  
HOOK CORD

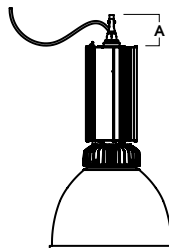

A
4.0
101.6 mm

**NM**  
NO MOUNT



# MOUNTING & ACCESSORIES

SOME OPTIONS NOT AVAILABLE ON ALL FIXTURES. CONSULT SPECIFICATION SHEETS. SEE INDIVIDUAL SPECIFICATION SHEETS OR CONSULT FACTORY FOR ADDITIONAL INFORMATION. NOTE: THIS IS TYPICAL OF RLM SPECIFICATION FOR MOUNTING. INDIVIDUAL FIXTURES OR PROJECTS MAY HAVE SPECIALIZED REQUIREMENTS.



## ADDITIONS

**FS - FUSING**

Slow blow type fuse protects fixture against voltage surges. Factory installed.



**LSP10 - SM - SURGE PROTECTOR**

Surge protector absorbs transient electrical spikes and protects fixtures and electronics 120/277v. Re-sets after surge. Factory Installed.



## SAFETY CABLE OPTIONS

**SC1 - SAFETY CABLE**

1/16" stainless steel safety cable for added support. Standard kit is 18" and double barrel locks are provided. Approved for California seismic requirements. Rated at 50 lbs.



**SC2 - SAFETY CABLE**

1/16" Stainless steel cable holds door to fixture

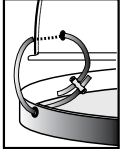

## OPTIONS

**DIFFUSER**

**TF3-6"** Frosted Diffuser



**DOOR**

**DR16D-16"** Spun Door



DR16D SHOWN WITH CN

**LENSES**





**CNFR**-Conical Frosted Lens  
**CN**-Conical Lens  
**DL**-Drop Lens  
**FO**-White Optical Acrylic  
**PP**-Prismatic Polycarbonate  
**PC**-Clear Polycarbonate

**GUARD OPTION**

**WAG16-16"** Wire Guard

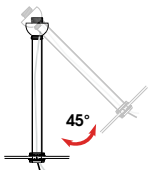
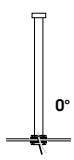
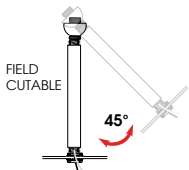
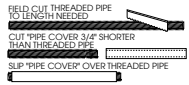

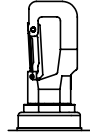
## MOUNTING TYPES

<p><b>HM*</b> HANG STRAIGHT 45° SWIVEL 5/8" OD STEM - 3/8" IP</p>  <p>ORDER: <b>HM</b> (Length) SPECIFY LENGTH:  <b>HM3 - 3"</b>    <b>HM24 - 24"</b>  <b>HM6 - 6"</b>    <b>HM36 - 36"</b>  <b>HM12 - 12"</b>   <b>HM48 - 48"</b>  <b>HM18 - 18"</b>   <b>HM72 - 72"</b>  <b>HMLC(XX)</b>                  Custom Length                  (Specify in Inches)</p>	<p><b>PM*</b> RIGID PENDANT MOUNT RIGID 5/8" OD STEM - 3/8" IP</p>  <p>ORDER: <b>PM</b> (Length) SPECIFY LENGTH:  <b>PM3 - 3"</b>    <b>PM24 - 24"</b>  <b>PM6 - 6"</b>    <b>PM36 - 36"</b>  <b>PM12 - 12"</b>   <b>PM48 - 48"</b>  <b>PM18 - 18"</b>   <b>PM72 - 72"</b>  <b>PMLC(XX)</b>                  Custom Length                  (Specify in Inches)</p>	<p><b>AT**</b> HANG STRAIGHT ALL THREAD 45° SWIVEL 5/8" OD STEM - 1/4" IP</p>  <p>ORDER: <b>AT</b> (Length) SPECIFY LENGTH:  <b>AT12 - 12"</b>  <b>AT24 - 24"</b>  <b>AT36 - 36"</b></p>  <p style="font-size: x-small;">FIELD CUT THREADED PIPE TO LENGTH NEEDED                  CUT PIPE COVER 3/4" SHORTER THAN THREADED PIPE                  SLIP PIPE COVER OVER THREADED PIPE</p>	<p><b>CD</b> CORD / CABLE MOUNT SJ CORD WITH 1/16 SS CABLE</p>  <p>ORDER: <b>CD</b> (Length) SPECIFY LENGTH:  <b>CD36 - 36"</b>  <b>CD72 - 72"</b>  <b>CD144 - 144"</b>  <b>CDLC(XX)</b>                  Custom Length                  (Specify in Inches)</p>	<p><b>HC</b> HOOK &amp; CORD FOR INDEPENDENT MOUNTING</p>  <p>ORDER: <b>HC</b> (Length) SPECIFY LENGTH:  <b>HC36 - 36"</b>  <b>HC72 - 72"</b>  <b>HC144 - 144"</b>  <b>HCLC(XX)</b>                  Custom Length                  (Specify in Inches)</p>	<p><b>NMX</b> 1/2" NPT Hub 3/4" NPT Hub FOR INDEPENDENT MOUNTING</p>  <p>ORDER: <b>NMX</b> (Length) SPECIFY LENGTH:  <b>NM2(12)</b> - 12" Leads are Standard  <b>NM3(12)</b> - 12" Leads are Standard  <b>NMXLC(XX)</b>                  Custom Length                  (Specify in Inches)</p>
---	--	---	---	--	--

\*MAXIMUM ONE PIECE STEM LENGTH IS 72". \*\*MAXIMUM ONE PIECE STEM LENGTH IS 36". LONGER LENGTHS ARE POSSIBLE USING MULTIPLE STEMS AND COUPLERS.

## EMERGENCY BATTERY OPTIONS

**EMCR - LARGE DRIVER CANOPY FOR 10W EMERGENCY BATTERY**

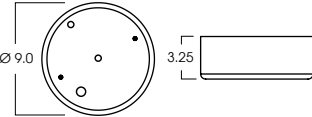

A	B	C
1.3	12.6	13.0

## REMOTE EMERGENCY BATTERY OPTIONS

**EMRM\* - 7W REMOTE EMERGENCY BATTERY (60' MAX)**

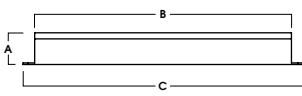

A	B	C
1.3	12.6	13.0

**EMEN\* - 7W REMOTE EMERGENCY BATTERY WITH ENCLOSURE (60' MAX)**

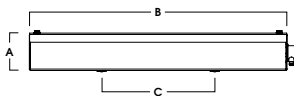

A	B	C
2.0	17.0	6.2

\*OTHER EM BATTERY SIZES AVAILABLE. CONSULT FACTORY

# 16" ALUMINUM

## EXL SERIES / PHOTOMETRIC DATA



ALxxx16LX-140L-35K-EX-AL16

CANDLEPOWER CURVE	INTENSITY	ZONAL LUMENS	SINGLE UNIT: PERFORMANCE INITIAL FOOTCANDLES BASED ON IES BEAM ANGLE	MULTIPLE UNITS: PERFORMANCE 80/50/20% REFLECTANCES INITIAL FOOTCANDLES AND WATTS PER SQUARE FOOT										
	0.00°	0° - 10°	736	6%	Mounting Height AFF	FC at Center on Floor	Beam Diameter	FC at Beam Edge	Ceiling Height	Fixture Spacing	RCR 2		RCR 4	
	0.00°	0° - 20°	2,739	23%							FC +	W/Sq. Ft.	FC +	W/Sq. Ft.
	5.00°	0° - 30°	5,572	48%	10.0'	76 fc	15.0'	37 fc	22'	20'	29	0.30	24	0.30
	10.00°	0° - 40°	8,316	71%	12.0'	53 fc	18.0'	26 fc	26'	22'	18	0.19	15	0.19
	15.00°	0° - 60°	10,456	90%	14.0'	39 fc	21.0'	19 fc	32'	24'	17	0.17	20	0.25
	20.00°	0° - 80°	11,572	99%	16.0'	30 fc	24.0'	14 fc	Delivered Illuminance Rating: (DIR)					
	30.00°	0° - 90°	11,669	100%	20.0'	19 fc	30.0'	9 fc	2' Suspension Length					
	40.00°	Total	11,669	100%	24.0'	13 fc	36.0'	6 fc	Square rooms used for multiple units:					
	50.00°				28.0'	10 fc	42.0'	5 fc	- RCR 2: Length & Width = Ceiling Ht. - 6.5' x 5.00					
	60.00°				32.0'	7 fc	48.0'	4 fc	- RCR 4: Length & Width = Ceiling Ht. - 6.5' x 2.50					
	70.00°								+ Average Footcandles at 2.5' Above Floor					
80.00°								* Exceeds spacing criteria by 14%						
90.00°								** Exceeds spacing criteria by -0%						
								*** Exceeds spacing criteria by -17%						
Delivered Lumens: 11,669	CP at 0deg (Nadir): 7,638	Beam Angle: 73.56	Lamp Multiplier: 67L x 0.47, 100L x 0.71, 130L x 0.93											
Luminaire Watts: 111.89	CRI: 85	Spacing Ratio: 1.13	CCT Multiplier: 40K x 1.03, 30K x 0.979, 27K x 0.959											
LER: 104.29														

ALxxx16LX-140L-35K-EX-AL16-BC16-CN

CANDLEPOWER CURVE	INTENSITY	ZONAL LUMENS	SINGLE UNIT: PERFORMANCE INITIAL FOOTCANDLES BASED ON IES BEAM ANGLE	MULTIPLE UNITS: PERFORMANCE 80/50/20% REFLECTANCES INITIAL FOOTCANDLES AND WATTS PER SQUARE FOOT										
	0.00°	0° - 10°	352	4%	Mounting Height AFF	FC at Center on Floor	Beam Diameter	FC at Beam Edge	Ceiling Height	Fixture Spacing	RCR 2		RCR 4	
	0.00°	0° - 20°	1,640	19%							FC +	W/Sq. Ft.	FC +	W/Sq. Ft.
	5.00°	0° - 30°	3,889	44%	10.0'	31 fc	16.3'	15 fc	22'	22'	12	0.17	18	0.30
	10.00°	0° - 40°	6,080	69%	12.0'	21 fc	19.6'	10 fc	26'	24'	14	0.19	11	0.19
	15.00°	0° - 60°	7,937	91%	14.0'	16 fc	22.8'	7 fc	32'	28'	8	0.11	7	0.11
	20.00°	0° - 80°	8,708	99%	16.0'	12 fc	26.1'	6 fc	Delivered Illuminance Rating: (DIR)					
	30.00°	0° - 90°	8,766	100%	20.0'	8 fc	32.6'	4 fc	73 FC per W/Sq. Ft.					
	40.00°	Total	8,766	100%	24.0'	5 fc	39.2'	3 fc	60 FC per W/Sq. Ft.					
	50.00°				28.0'	4 fc	45.7'	2 fc	2' Suspension Length					
	60.00°				32.0'	3 fc	52.2'	1 fc	Square rooms used for multiple units:					
	70.00°								- RCR 2: Length & Width = Ceiling Ht. - 6.5' x 5.00					
80.00°								- RCR 4: Length & Width = Ceiling Ht. - 6.5' x 2.50						
90.00°								+ Average Footcandles at 2.5' Above Floor						
								* Exceeds spacing criteria by -6%						
								** Exceeds spacing criteria by -18%						
								*** Exceeds spacing criteria by -27%						
Delivered Lumens: 8,766	CP at 0deg (Nadir): 3,096	Beam Angle: 78.35	Lamp Multiplier: 65L x 0.47, 100L x 0.71, 130L x 0.93											
Luminaire Watts: 111.89	CRI: 85	Spacing Ratio: 1.51	CCT Multiplier: 40K x 1.03, 30K x 0.979, 27K x 0.959											
LER: 78.34														

ALxxx16LX-140L-35K-EX-AL16-BC16-DL

CANDLEPOWER CURVE	INTENSITY	ZONAL LUMENS	SINGLE UNIT: PERFORMANCE INITIAL FOOTCANDLES BASED ON IES BEAM ANGLE	MULTIPLE UNITS: PERFORMANCE 80/50/20% REFLECTANCES INITIAL FOOTCANDLES AND WATTS PER SQUARE FOOT								
	0.00°	0° - 10°	361	4%	Mounting Height AFF	FC at Center on Floor	Ceiling Height	Fixture Spacing	RCR 2		RCR 4	
	0.00°	0° - 20°	1,224	13%					FC +	W/Sq. Ft.	FC +	W/Sq. Ft.
	20.00°	0° - 30°	2,415	27%	10.0'	41 fc	22'	12'	47	0.67	37	0.67
	40.00°	0° - 40°	3,779	42%	12.0'	29 fc	26'	14'	40	0.58	23	0.42
	60.00°	0° - 60°	7,065	78%	14.0'	21 fc	32'	16'	31	0.44	24	0.44
	80.00°	0° - 80°	8,395	92%	16.0'	16 fc	Delivered Illuminance Rating: (DIR)					
	90.00°	0° - 90°	8,774	96%	20.0'	10 fc	70 FC per W/Sq. Ft.					
	100.00°	Total	9,106	100%	24.0'	7 fc	55 FC per W/Sq. Ft.					
	110.00°				28.0'	5 fc	2' Suspension Length					
	120.00°				32.0'	4 fc	Square rooms used for multiple units:					
	140.00°								- RCR 2: Length & Width = Ceiling Ht. - 6.5' x 5.00			
160.00°								- RCR 4: Length & Width = Ceiling Ht. - 6.5' x 2.50				
180.00°								+ Average Footcandles at 2.5' Above Floor				
								* Exceeds spacing criteria by -10%				
								** Exceeds spacing criteria by -17%				
								*** Exceeds spacing criteria by -27%				
Delivered Lumens: 9,106	CP at 0deg (Nadir): 4,108	Beam Angle: 120.110°	Lamp Multiplier: 65L x 0.47, 100L x 0.71, 130L x 0.93									
Luminaire Watts: 111.89	CRI: 85		CCT Multiplier: 40K x 1.03, 30K x 0.979, 27K x 0.959									
LER: 81.38												

# 16" ALUMINUM

## EXL SERIES / PHOTOMETRIC DATA



ALxxx16LX-140L-35K-EX-AL16-BC16-FO

CANDLEPOWER CURVE	INTENSITY	ZONAL LUMENS	SINGLE UNIT: PERFORMANCE INITIAL FOOTCANDLES BASED ON IES BEAM ANGLE				MULTIPLE UNITS: PERFORMANCE 80/50/20% REFLECTANCES INITIAL FOOTCANDLES AND WATTS PER SQUARE FOOT							
			Mounting Height AFF	FC at Center on Floor	Beam Diameter	FC at Beam Edge	Ceiling Height	Fixture Spacing	RCR 2		RCR 4			
	0.00°	0° - 10°	303	4%	10.0'	32 fc	25.4'	12 fc	22'	20'	19	0.30	15	0.30
	0.00° 3,174	0° - 20°	1,147	14%	12.0'	22 fc	30.5'	8 fc	26'	22'	12	0.19	10	0.19
	5.00° 3,155	0° - 30°	2,392	29%	14.0'	16 fc	35.6'	6 fc	32'	24'	11	0.17	13	0.25
	10.00° 3,094	0° - 40°	3,847	47%	16.0'	12 fc	40.7'	5 fc	Delivered Illuminance Rating: (DIR)					
	15.00° 2,993	0° - 60°	6,596	81%	20.0'	8 fc	50.9'	3 fc	2' Suspension Length					
	20.00° 2,865	0° - 80°	8,035	99%	24.0'	6 fc	61.0'	2 fc	Square rooms used for multiple units:					
	30.00° 2,524	0° - 90°	8,124	100%	28.0'	4 fc	71.2'	1 fc	- RCR 2: Length & Width = Ceiling Ht. - 6.5' x 5.00					
	40.00° 2,115	Total	8,124	100%	32.0'	3 fc	81.4'	1 fc	- RCR 4: Length & Width = Ceiling Ht. - 6.5' x 2.50					
	50.00° 1,674								+ Average Footcandles at 2.5' Above Floor					
	60.00° 1,200								* Exceeds spacing criteria by 9%					
	70.00° 707								** Exceeds spacing criteria by -4%					
	80.00° 239								*** Exceeds spacing criteria by -20%					
	90.00° 0													
Delivered Lumens: 8,124 Luminaire Watts: 111.89 LER: 72.61	CP at 0deg (Nadir): 3,174 CRI: 85	Beam Angle: 103.61 Spacing Ratio: 1.18	Lamp Multiplier: 65L x 0.47, 100L 0.71, 130L x 0.93 CCT Multiplier: 40K x 1.03, 30K x 0.979, 27K x 0.959											

ALxxx16LX-140L-35K-EX-AL16-BC16-PP

CANDLEPOWER CURVE	INTENSITY	ZONAL LUMENS	SINGLE UNIT: PERFORMANCE INITIAL FOOTCANDLES BASED ON IES BEAM ANGLE				MULTIPLE UNITS: PERFORMANCE 80/50/20% REFLECTANCES INITIAL FOOTCANDLES AND WATTS PER SQUARE FOOT							
			Mounting Height AFF	FC at Center on Floor	Beam Diameter	FC at Beam Edge	Ceiling Height	Fixture Spacing	RCR 2		RCR 4			
	0.00°	0° - 10°	565	6%	10.0'	61 fc	12.7'	30 fc	22'	12'	49	0.67	40	0.67
	0.00° 6,074	0° - 20°	1,881	21%	12.0'	42 fc	15.2'	21 fc	26'	14'	42	0.58	25	0.42
	5.00° 6,015	0° - 30°	3,570	40%	14.0'	31 fc	17.8'	15 fc	32'	16'	32	0.44	26	0.44
	10.00° 5,442	0° - 40°	5,337	60%	16.0'	24 fc	20.3'	12 fc	Delivered Illuminance Rating: (DIR)					
	15.00° 4,652	0° - 60°	7,950	90%	20.0'	15 fc	25.4'	7 fc	73 FC per W/Sq. Ft.					
	20.00° 4,112	0° - 80°	8,831	99%	24.0'	11 fc	30.5'	5 fc	60 FC per W/Sq. Ft.					
	30.00° 3,260	0° - 90°	8,879	100%	28.0'	8 fc	35.6'	4 fc	2' Suspension Length					
	40.00° 2,438	Total	8,879	100%	32.0'	6 fc	40.7'	3 fc	Square rooms used for multiple units:					
	50.00° 1,654								- RCR 2: Length & Width = Ceiling Ht. - 6.5' x 5.00					
	60.00° 852								- RCR 4: Length & Width = Ceiling Ht. - 6.5' x 2.50					
	70.00° 425								+ Average Footcandles at 2.5' Above Floor					
	80.00° 144								* Exceeds spacing criteria by -8%					
	90.00° 0								** Exceeds spacing criteria by -15%					
								*** Exceeds spacing criteria by -25%						
Delivered Lumens: 8,879 Luminaire Watts: 111.89 LER: 79.35	CP at 0deg (Nadir): 6,074 CRI: 85	Beam Angle: 65.17 Spacing Ratio: 0.84	Lamp Multiplier: 65L x 0.47, 100L x 0.71, 130L x 0.93 CCT Multiplier: 40K x 1.03, 30K x 0.979, 27K x 0.959											

ALxxx16LX-140L-35K-EX-AL16-BC16-PC

CANDLEPOWER CURVE	INTENSITY	ZONAL LUMENS	SINGLE UNIT: PERFORMANCE INITIAL FOOTCANDLES BASED ON IES BEAM ANGLE				MULTIPLE UNITS: PERFORMANCE 80/50/20% REFLECTANCES INITIAL FOOTCANDLES AND WATTS PER SQUARE FOOT							
			Mounting Height AFF	FC at Center on Floor	Beam Diameter	FC at Beam Edge	Ceiling Height	Fixture Spacing	RCR 2		RCR 4			
	0.00°	0° - 10°	618	7%	10.0'	64 fc	14.3'	31 fc	22'	20'	24	0.30	20	0.30
	0.00° 6,421	0° - 20°	2,291	24%	12.0'	45 fc	17.2'	22 fc	26'	22'	15	0.19	12	0.19
	5.00° 6,413	0° - 30°	4,657	50%	14.0'	33 fc	20.1'	16 fc	32'	24'	14	0.17	16	0.25
	10.00° 6,310	0° - 40°	6,743	72%	16.0'	25 fc	22.9'	12 fc	Delivered Illuminance Rating: (DIR)					
	15.00° 5,998	0° - 60°	8,537	91%	20.0'	16 fc	28.6'	8 fc	79 FC per W/Sq. Ft.					
	20.00° 5,500	0° - 80°	9,350	100%	24.0'	11 fc	34.4'	5 fc	66 FC per W/Sq. Ft.					
	30.00° 4,787	0° - 90°	9,380	100%	28.0'	8 fc	40.1'	4 fc	2' Suspension Length					
	40.00° 1,854	Total	9,380	100%	32.0'	6 fc	45.8'	3 fc	Square rooms used for multiple units:					
	50.00° 1,065								- RCR 2: Length & Width = Ceiling Ht. - 6.5' x 5.00					
	60.00° 733								- RCR 4: Length & Width = Ceiling Ht. - 6.5' x 2.50					
	70.00° 386								+ Average Footcandles at 2.5' Above Floor					
	80.00° 95								* Exceeds spacing criteria by 15%					
	90.00° 0								** Exceeds spacing criteria by 1%					
								*** Exceeds spacing criteria by -16%						
Delivered Lumens: 9,380 Luminaire Watts: 111.89 LER: 83.83	CP at 0deg (Nadir): 6,421 CRI: 85	Beam Angle: 71.19 Spacing Ratio: 1.12	Lamp Multiplier: 65L x 0.47, 100L x 0.71, 130L x 0.93 CCT Multiplier: 40K x 1.03, 30K x 0.979, 27K x 0.959											

# 16" ALUMINUM

## EXL SERIES / PHOTOMETRIC DATA



ALxxx16LX-140L-35K-EX-AL16-BC16-CNFR

CANDLEPOWER CURVE	INTENSITY	ZONAL LUMENS	SINGLE UNIT: PERFORMANCE INITIAL FOOTCANDLES BASED ON IES BEAM ANGLE	MULTIPLE UNITS: PERFORMANCE 80/50/20% REFLECTANCES INITIAL FOOTCANDLES AND WATTS PER SQUARE FOOT																																									
	0.00°	0° - 10°	401	4%	<table border="1"> <thead> <tr> <th rowspan="2">Ceiling Height</th> <th rowspan="2">Fixture Spacing</th> <th colspan="2">RCR 2</th> <th colspan="2">RCR 4</th> </tr> <tr> <th>FC *</th> <th>W/Sq. Ft.</th> <th>FC *</th> <th>W/Sq. Ft.</th> </tr> </thead> <tbody> <tr> <td>22'</td> <td>20' *</td> <td>22</td> <td>0.30</td> <td>18</td> <td>0.30</td> </tr> <tr> <td>26'</td> <td>22' **</td> <td>14</td> <td>0.19</td> <td>12</td> <td>0.19</td> </tr> <tr> <td>32'</td> <td>24' ***</td> <td>13</td> <td>0.17</td> <td>7</td> <td>0.11</td> </tr> <tr> <td colspan="2">Delivered Illuminance Rating: (DIR)</td> <td colspan="2">75 FC per W/Sq. Ft.</td> <td colspan="2">62 FC per W/Sq. Ft.</td> </tr> <tr> <td colspan="6">                     2' Suspension Length                      Square rooms used for multiple units:                      - RCR 2: Length &amp; Width = Ceiling Ht. - 6.5' x 5.00                      - RCR 4: Length &amp; Width = Ceiling Ht. - 6.5' x 2.50                      * Average Footcandles at 2.5' Above Floor                      * Exceeds spacing criteria by -4%                      ** Exceeds spacing criteria by -16%                      *** Exceeds spacing criteria by -30%                 </td> </tr> </tbody> </table>	Ceiling Height	Fixture Spacing	RCR 2		RCR 4		FC *	W/Sq. Ft.	FC *	W/Sq. Ft.	22'	20' *	22	0.30	18	0.30	26'	22' **	14	0.19	12	0.19	32'	24' ***	13	0.17	7	0.11	Delivered Illuminance Rating: (DIR)		75 FC per W/Sq. Ft.		62 FC per W/Sq. Ft.		2' Suspension Length Square rooms used for multiple units: - RCR 2: Length & Width = Ceiling Ht. - 6.5' x 5.00 - RCR 4: Length & Width = Ceiling Ht. - 6.5' x 2.50 * Average Footcandles at 2.5' Above Floor * Exceeds spacing criteria by -4% ** Exceeds spacing criteria by -16% *** Exceeds spacing criteria by -30%					
	Ceiling Height	Fixture Spacing	RCR 2					RCR 4																																					
			FC *	W/Sq. Ft.		FC *	W/Sq. Ft.																																						
	22'	20' *	22	0.30		18	0.30																																						
	26'	22' **	14	0.19		12	0.19																																						
	32'	24' ***	13	0.17		7	0.11																																						
	Delivered Illuminance Rating: (DIR)		75 FC per W/Sq. Ft.			62 FC per W/Sq. Ft.																																							
	2' Suspension Length Square rooms used for multiple units: - RCR 2: Length & Width = Ceiling Ht. - 6.5' x 5.00 - RCR 4: Length & Width = Ceiling Ht. - 6.5' x 2.50 * Average Footcandles at 2.5' Above Floor * Exceeds spacing criteria by -4% ** Exceeds spacing criteria by -16% *** Exceeds spacing criteria by -30%																																												
	0.00°	3,887	0° - 20°	1,697		19%																																							
	5.00°	4,051	0° - 30°	3,757		41%																																							
	10.00°	4,318	0° - 40°	5,781		63%																																							
15.00°	4,575	0° - 60°	8,094	89%																																									
20.00°	4,704	0° - 80°	9,041	99%																																									
30.00°	4,051	0° - 90°	9,121	100%																																									
40.00°	2,427	Total	9,121	100%																																									
50.00°	1,316																																												
60.00°	822																																												
70.00°	453																																												
80.00°	166																																												
90.00°	1																																												

Delivered Lumens: 9,121  
 Luminaire Watts: 111.89  
 LER: 81.52

CP at 0deg (Nadir): 3,887  
 CRI: 85

Beam Angle: 80.91  
 Spacing Ratio: 1.35

Lamp Multiplier: 65L x 0.47, 100L x 0.71, 130L x 0.93  
 CCT Multiplier: 40K x 1.03, 30K x 0.979, 27K x 0.959

# COLOR OPTIONS - POWDER COAT PAINT FINISHES

NOTE: NO PRINTED IMAGE CAN EQUAL THE EXACT COLOR OF FINISH ON METAL.  
SEE INDIVIDUAL SPECIFICATION SHEETS OR CONSULT FACTORY FOR ADDITIONAL INFORMATION.



## STANDARD CORD / STEM / CANOPY FINISHES

FIXTURE COLOR	STANDARD CORD COLOR	STANDARD CANOPY / STEM COLOR
Matte White, Textured White	Matte White	Matte White
Gloss White	Matte White	Gloss White
Matte Black, Gloss Black, Textured Black	Matte Black	Matte Black
All Others	Matte Black	Same Color as Fixture
Custom Color	Contact Factory	Contact Factory

## PAINT TIMES

TIER	COST	AVERAGE PAINT TIME*
Tier 1 - Standard Finishes	\$	⌚
Tier 2 - Typical Finishes	\$\$	⌚⌚
Custom Color	Contact Factory	Contact Factory

\*CONTACT FACTORY FOR SPECIFIC PRODUCT LEAD TIMES

## TIER 1 - STANDARD FINISHES

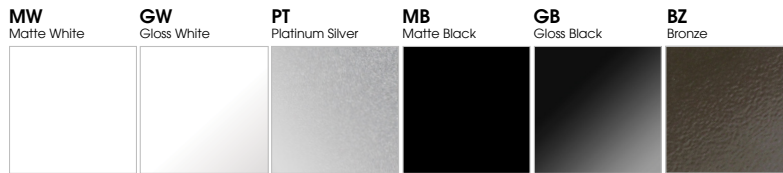

## TIER 2 - TYPICAL FINISHES



## CUSTOM COLOR FINISHES

CONTACT FACTORY

**CC**  
Custom Color



\*UNAVAILABLE FOR WET LOCATION