



16" PRISMATIC AF SERIES



PRAF16LX

APPLICATION

16" Arc Pendant evokes industrial age designs while using the latest LED technology for excellent general illumination. Prismatic refractor provides horizontal and vertical distribution. Laser cut decorative arm.

FEATURES

Extruded Fixture Housing (EXT). Single-stage optical system for smooth light distribution. LED module and driver designed for ease of maintenance and replacement. Post-look refractor retention ring will absorb shocks and impacts. Optional safety cable. Variety of mounting methods.

FINISH

Multi-stage polyester powder-coat process applied on our dedicated paint lines. Variety of standard and custom finishes are available. All exposed materials are chromate pretreated to resist corrosion.

ELECTRONICS

LED system features high brightness white Nichia LEDs. 3-step MacAdam Ellipse binning. Standard CRI: 80+. Higher CRI, R9 and custom LED configurations are available; consult factory. Variety of electronic 120V/277V and dimming drivers. LED module is 2 circuit with 2 drivers for multicircuit option.

CONSTRUCTION

Extruded and machined 6063-T5 aluminum housing. Graphite gasket for optimal thermal management. Die-cast aluminum heat sink. Refractor made of cast UV stabilized acrylic. ARC pendant arms and deco ring are laser cut 5052 aluminum.

CODE COMPLIANCE

BAA compliant. ETL certified to meet US and Canadian standards. Suitable for dry or damp locations. Manufactured and tested to UL standards No. 1598/8750.

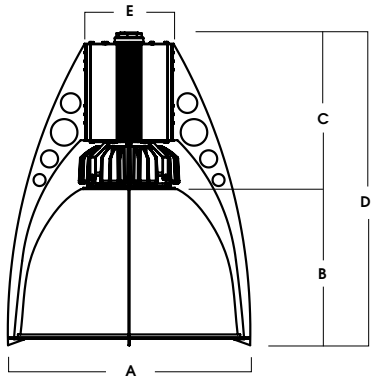

A	B	C	D	E
17.6 447.0 mm	11.4 289.6 mm	10.6 269.2 mm	22.0 558.8 mm	6.5 165.1 mm

LUMENS / WATTAGE DATA				
PART NUMBER	SOURCE LUMENS ¹	DELIVERED LUMENS ²	SYSTEM WATTS	LPW
PRAF16LX65L	6500	5587	56.2	99
PRAF16LX100L	10000	8381	81.1	103
PRAF16LX130L	13000	11025	103.9	106
PRAF16LX140L	14000	11872	111.9	106

SERIES	LUMENS ¹	CCT	DRIVER / DIMMING ²	OPTIONS ³	MOUNTING ⁵	REFRACTOR	DIFFUSER OPTION	TIER OPTIONS	FINISH ⁹
PRAF16LX	65L 6500 Lm	27K 2700K	EX Electronic Driver, 120V/277V DS10X 10%, 0-10V, 120V/277V DO10X 1%, 10-0V, 120V/277V DO103 1%, 0-10V, 347V	SAFETY OPTIONS FS Fusing 2CIR 2 Circuit SC1 Safety Cable SC2 Safety Cable Reflector to door EMERGENCY BATTERY OPTIONS EMIT 7W Emergency Battery Test Switch EMCR 10W Canopy Mounted EM EMRM 7W Remote EM EMEN 7W Remote with Enclosure	HM ⁶ Hang Straight AT ⁶ Hang Straight All Thread PM ⁶ Rigid Pendant CD ⁶ Cord / Cable Mount HC ⁶ Hook & Cord NM2 ⁶ 1/2" NPT Hub NM3 ⁶ 3/8" NPT Hub	DF16 16" Diffuse PR16 16" Clear OP16 16" Opal	TF3 6" Frosted Diffuser	AFPF Aluminum Fins w/ Decorative Perforations and 1-Metal Tier Ring AFSF Aluminum Decorative Arm with Slots and 1-Metal Tier Ring	MW ⁹ Matte White MB ⁹ Matte Black PT ⁹ Platinum Silver CC Custom Color See Page 5 for Full Range of Color Options (83-90081)
	100L 10000 Lm	30K 3000K							
	130L 13000 Lm	35K 3500K							
	140L 14000 Lm	40K 4000K							

EXAMPLE: PRAF16LX100L35KEX/CD36/PR16/AFP/MW

NOTES:
 1 Nominal Source Lumens at 35K 2 Nominal Delivered Lumens at 35K with PR16AFPMMW 3 Contact Factory for Additional Options 4 See Product Options Page For Details 5 See Mounting Page for Details on Components and Finishes 6 Specify Length in Inches: See Mounting Page for Available Lengths 7 Mounting Supplied by Others 8 See Color Page for More Options / Consult Factory for Special Finishes 9 Standard Finishes



PROJECT: _____
 TYPE: _____



Dimensions and values shown are nominal. Spectrum Lighting continually works to improve products and reserves the right to make changes which may alter the performance or appearance of products.

16" PRISMATIC

AF SERIES / FIXTURE OPTIONS



STANDARD FINISHES

MW
MATTE WHITE



MB
MATTE BLACK



PT
PLATINUM SILVER



DECORATIVE ARMS

AFPF
LASER CUT DECO ARM WITH HOLES

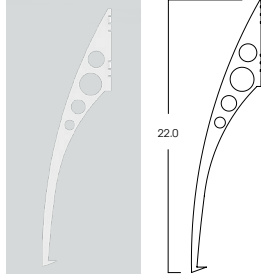

AFSF
LASER CUT DECO ARM WITH SLOTS

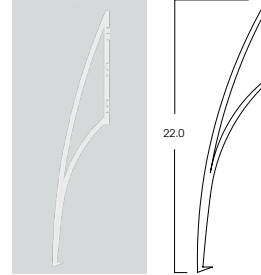

MOUNTING TYPES

HM / AT / PM
HANG STRAIGHT / ALL THREAD / PENDANT

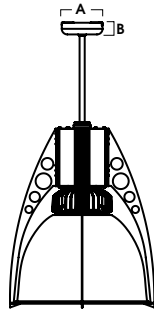

A	B
5.0	1.5
127 mm	38.1 mm

CD
CORD / CABLE MOUNT

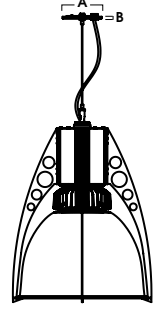

A	B
5.0	.25
63.5 mm	6.35 mm

HC
HOOK CORD

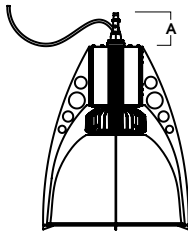

A
4.0
101.6 mm

NM
NO MOUNT

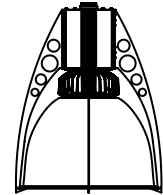



MOUNTING & ACCESSORIES

SOME OPTIONS NOT AVAILABLE ON ALL FIXTURES. CONSULT SPECIFICATION SHEETS. SEE INDIVIDUAL SPECIFICATION SHEETS OR CONSULT FACTORY FOR ADDITIONAL INFORMATION. NOTE: THIS IS TYPICAL OF RLM SPECIFICATION FOR MOUNTING. INDIVIDUAL FIXTURES OR PROJECTS MAY HAVE SPECIALIZED REQUIREMENTS.



ADDITIONS

<p>FS - FUSING</p> <p>Slow blow type fuse protects fixture against voltage surges. Factory installed.</p> 	<p>LSP10 - SM - SURGE PROTECTOR</p> <p>Surge protector absorbs transient electrical spikes and protects fixtures and electronics 120/277v. Re-sets after surge. Factory Installed.</p> 
--	---





SAFETY CABLE OPTIONS

<p>SC1 - SAFETY CABLE</p> <p>1/16" stainless steel safety cable for added support. Standard kit is 18" and double barrel locks are provided. Approved for California seismic requirements. Rated at 50 lbs.</p> 	<p>SC2 - SAFETY CABLE</p> <p>1/16" Stainless steel cable holds door to fixture</p> 
--	---

OPTIONS

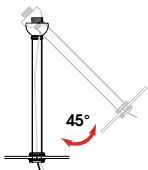
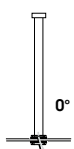
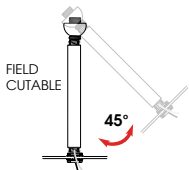
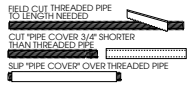
<p>DIFFUSER</p> <p>TF3-6" Frosted Diffuser</p> 	<p>TIER OPTIONS</p> <p>APPF-Aluminum Fins w/ Decorative Perforations and 1-Metal Tier Ring AFSF-Aluminum Decorative Arm with Slots and 1-Metal Tier Ring</p>
--	--

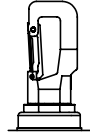
MOUNTING TYPES

<p>HM* HANG STRAIGHT 45° SWIVEL 5/8" OD STEM - 3/8" IP</p>  <p>ORDER: HM (Length) SPECIFY LENGTH: HM3 - 3" HM24 - 24" HM6 - 6" HM36 - 36" HM12 - 12" HM48 - 48" HM18 - 18" HM72 - 72" HMLC(XX) Custom Length (Specify in Inches)</p>	<p>PM* RIGID PENDANT MOUNT RIGID 5/8" OD STEM - 3/8" IP</p>  <p>ORDER: PM (Length) SPECIFY LENGTH: PM3 - 3" PM24 - 24" PM6 - 6" PM36 - 36" PM12 - 12" PM48 - 48" PM18 - 18" PM72 - 72" PMLC(XX) Custom Length (Specify in Inches)</p>	<p>AT** HANG STRAIGHT ALL THREAD 45° SWIVEL 5/8" OD STEM - 1/4" IP</p>  <p>ORDER: AT (Length) SPECIFY LENGTH: AT12 - 12" AT24 - 24" AT36 - 36"</p> 	<p>CD CORD / CABLE MOUNT SJ CORD WITH 1/16 SS CABLE</p>  <p>ORDER: CD (Length) SPECIFY LENGTH: CD36 - 36" CD72 - 72" CD144 - 144" CDLC(XX) Custom Length (Specify in Inches)</p>	<p>HC HOOK & CORD FOR INDEPENDENT MOUNTING</p>  <p>ORDER: HC (Length) SPECIFY LENGTH: HC36 - 36" HC72 - 72" HC144 - 144" HCLC(XX) Custom Length (Specify in Inches)</p>	<p>NMX 1/2" NPT Hub 3/4" NPT Hub FOR INDEPENDENT MOUNTING</p>  <p>ORDER: NMX (Length) SPECIFY LENGTH: NM2(12) - 12" Leads are Standard NM3(12) - 12" Leads are Standard NMXLC(XX) Custom Length (Specify in Inches)</p>
---	--	---	---	--	--

*MAXIMUM ONE PIECE STEM LENGTH IS 72". **MAXIMUM ONE PIECE STEM LENGTH IS 36". LONGER LENGTHS ARE POSSIBLE USING MULTIPLE STEMS AND COUPLERS.

EMERGENCY BATTERY OPTIONS

EMCR - LARGE DRIVER CANOPY FOR 10W EMERGENCY BATTERY

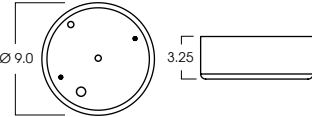

A	B	C
1.3	12.6	13.0

REMOTE EMERGENCY BATTERY OPTIONS

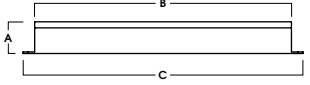
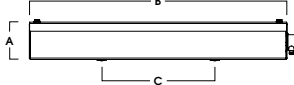
<p>EMRM* - 7W REMOTE EMERGENCY BATTERY (60' MAX)</p>  <table border="1"> <tr> <td>A</td> <td>B</td> <td>C</td> </tr> <tr> <td>1.3</td> <td>12.6</td> <td>13.0</td> </tr> </table>	A	B	C	1.3	12.6	13.0	<p>EMEN* - 7W REMOTE EMERGENCY BATTERY WITH ENCLOSURE (60' MAX)</p>  <table border="1"> <tr> <td>A</td> <td>B</td> <td>C</td> </tr> <tr> <td>2.0</td> <td>17.0</td> <td>6.2</td> </tr> </table>	A	B	C	2.0	17.0	6.2
A	B	C											
1.3	12.6	13.0											
A	B	C											
2.0	17.0	6.2											

*OTHER EM BATTERY SIZES AVAILABLE. CONSULT FACTORY

16" PRISMATIC

AF SERIES / PHOTOMETRIC DATA



PRAF-L-16LEDLX-140L-35K-E1-PR16-AFPF (or AFSF)-MW

CANDLEPOWER CURVE	INTENSITY	ZONAL LUMENS	SINGLE UNIT: PERFORMANCE INITIAL FOOTCANDLES BASED ON IES BEAM ANGLE				MULTIPLE UNITS: PERFORMANCE 80/50/20% REFLECTANCES INITIAL FOOTCANDLES AND WATTS PER SQUARE FOOT							
			Mounting Height AFF	FC at Center on Floor	Beam Diameter	FC at Beam Edge	Ceiling Height	Fixture Spacing	RCR 2		RCR 4			
	0.00°	0° - 10°	1,468	12%	10.0'	130 fc	10.7'	64 fc	22'	16' *	49	0.47	61	0.67
	0.00° 12,966	0° - 20°	4,591	38%	12.0'	90 fc	12.9'	45 fc	26'	18' **	31	0.29	39	0.42
	5.00° 12,913	0° - 30°	8,092	68%	14.0'	66 fc	15.0'	33 fc	32'	20' ***	26	0.25	23	0.25
	10.00° 12,640	0° - 40°	10,183	85%	16.0'	51 fc	17.2'	25 fc	Delivered Illuminance Rating: [DIR]		105 FC per W/Sq. Ft.		91 FC per W/Sq. Ft.	
	15.00° 11,552	0° - 60°	11,265	94%	20.0'	32 fc	21.5'	16 fc	2' Suspension Length Square rooms used for multiple units: - RCR 2: Length & Width = Ceiling Ht. - 6.5' x 5.00 - RCR 4: Length & Width = Ceiling Ht. - 6.5' x 2.50					
	20.00° 9,689	0° - 80°	11,597	97%	24.0'	23 fc	25.8'	11 fc	* Average Footcandles at 2.5' Above Floor					
	30.00° 5,746	0° - 90°	11,646	97%	28.0'	17 fc	30.1'	8 fc	** Exceeds spacing criteria by 19%					
	40.00° 1,465	Total	11,976	100%	32.0'	13 fc	34.4'	6 fc	*** Exceeds spacing criteria by -10%					
	50.00° 535								Lamp Multiplier: 65L x 0.47, 100L x 0.71, 130L x 0.93					
	60.00° 308								CCT Multiplier: 27K x 0.959, 30K x 0.979, 40K x 1.03					
	70.00° 156													
	80.00° 59													
	90.00° 42													

Delivered Lumens: 11,976
Luminaire Watts: 111.89
LER: 107.03

CP at 0deg (Nadir): 12,966
CRI: 85+

Beam Angle: 56.3
Spacing Ratio: 0.87

Lamp Multiplier: 65L x 0.47, 100L x 0.71, 130L x 0.93
CCT Multiplier: 27K x 0.959, 30K x 0.979, 40K x 1.03

COLOR OPTIONS - POWDER COAT PAINT FINISHES

NOTE: NO PRINTED IMAGE CAN EQUAL THE EXACT COLOR OF FINISH ON METAL.
SEE INDIVIDUAL SPECIFICATION SHEETS OR CONSULT FACTORY FOR ADDITIONAL INFORMATION.



STANDARD CORD / STEM / CANOPY FINISHES

FIXTURE COLOR	STANDARD CORD COLOR	STANDARD CANOPY / STEM COLOR
Matte White, Textured White	Matte White	Matte White
Gloss White	Matte White	Gloss White
Matte Black, Gloss Black, Textured Black	Matte Black	Matte Black
All Others	Matte Black	Same Color as Fixture
Custom Color	Contact Factory	Contact Factory

PAINT TIMES

TIER	COST	AVERAGE PAINT TIME*
Tier 1 - Standard Finishes	\$	⌚
Tier 2 - Typical Finishes	\$\$	⌚⌚
Custom Color	Contact Factory	Contact Factory

*CONTACT FACTORY FOR SPECIFIC PRODUCT LEAD TIMES

TIER 1 - STANDARD FINISHES

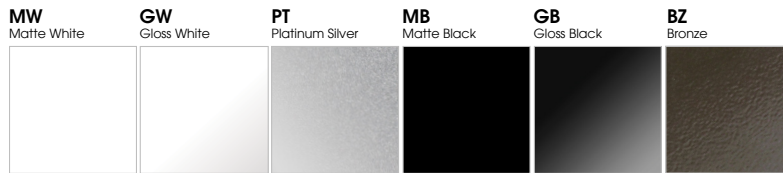

TIER 2 - TYPICAL FINISHES



CUSTOM COLOR FINISHES

CONTACT FACTORY

CC
Custom Color



*UNAVAILABLE FOR WET LOCATION