

22" ALUMINUM & PRISMATIC

DMD SERIES



DMD22GZ

APPLICATION

22" Lumen Max series performance pendant for low, mid-bay and high-bay applications. Aluminum reflector designed for maximum downlight. Prismatic refractor provides horizontal and vertical distribution.

FEATURES

Domed Fixture Housing (DMD) features a contemporary design and is easy to maintain. Single-stage optical system for smooth light distribution. 80 CRI minimum. Consult factory for high CRI or special applications. LED module and driver designed for ease of maintenance and replacement. Post-lock reflector retention ring will absorb shocks and impact. Optional safety cable. Variety of optical lenses, and mounting methods.

FINISH

Multi-stage polyester powder-coat process applied on our dedicated paint lines. Variety of standard and custom finishes are available. All exposed materials are chromate pretreated to resist corrosion. Standard Matte White interior finish on reflectors.

ELECTRONICS

LED system features high brightness white LED's. 3-step MacAdam Ellipse binning. Standard CRI: 80+. Higher CRI, R9 and custom LED configurations are available, consult factory.

CONSTRUCTION

Housing constructed of spun and machined aluminum. Die-cast aluminum heat sink. Reflector made of spun .060" aluminum. Refractor made of cast UV stabilized acrylic.

CODE COMPLIANCE

BAA compliant. ETL certified to meet US and Canadian standards. Suitable for dry or damp locations. Manufactured and tested to UL standards No. 1598/8750.

DLC LISTING

Not all combinations are listed on the Design Lights Consortium® QPL. Refer to designlights.org/search/ for most up-to-date list.

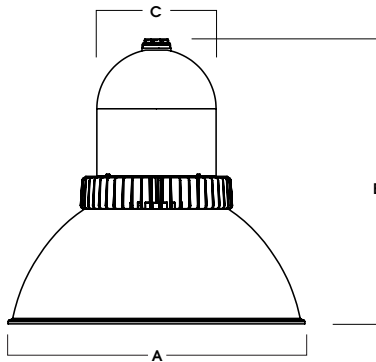

A	B	C
22.4 569.0 mm	21.5 546.1 mm	9.0 228.6 mm

Dimensioned with ALUMINUM SHADE

LUMENS / WATTAGE DATA				
PART NUMBER	SOURCE LUMENS ¹	DELIVERED LUMENS ²	SYSTEM WATTS	LPW
DMD22GZ240L/DF22	24000	23588	180	131

SERIES	LUMENS ¹	CCT	DRIVER / DIMMING ³	OPTIONS ⁴	MOUNTING ⁵	SHADE	DIFFUSER OPTIONS	FINISH ¹¹
DMD22GZ	240L 24000 Lm	35K 3500K 40K 4000K	DX 1%, 0-10V, 120V/277V	FS Fusing SC1 Safety Cable SC2 Safety Cable, Refractor to Door EMRM 7W Remote EM EMEN 7W Remote with Enclosure	HM ⁶ Hang Straight AT ⁶ Hang Straight All Thread PM ⁶ Rigid Pendant CD ⁶ Cord / Cable Mount HC ^{6,7} Hook & Cord NM2 ^{7,8} 1/2" NPT Hub NM3 ^{7,8} 3/4" NPT Hub EMERGENCY BATTERY OPTIONS	ALUMINUM AL22/MW Matte White Inside PRISMATIC DF22 22" Diffuse	DR22A ⁹ 22" Spun Door BC22 22" Band Clamp RS22 ¹⁰ 22" Refractor Shroud WAG22 22" Wire Guard	MW ¹² Matte White MB ¹² Matte Black PT ¹² Platinum Silver See Page 6 for Full Range of Color Options (83-90081)

DLC PREMIUM LISTED OPTIONS

EXAMPLE: DMD22GZ240L40KDX/HM36/DF22/MW

NOTES:
 1 Nominal Source Lumens at 35K 2 Nominal Delivered Lumens at 35K DX DF22 3 Contact Factory for Additional Options 4 See Product Options Page for Details 5 See Mounting Page for Details on Components 6 Specify Length in Inches; See Mounting Page for Available Lengths 7 Mounting Supplied by Others 8 12" Leads Unless Specified 9 Same Finish as Housing 10 Same Finish as Housing / For Use with Prismatic Shades Only 11 See Color Page for More Options/Consult Factory for Special Finishes 12 Standard Finishes



PROJECT: _____
 TYPE: _____



Dimensions and values shown are nominal. Spectrum Lighting continually works to improve products and reserves the right to make changes which may alter the performance or appearance of products.

22" ALUMINUM & PRISMATIC

DMD SERIES / FIXTURE OPTIONS



SERIES TYPE

ALUMINUM

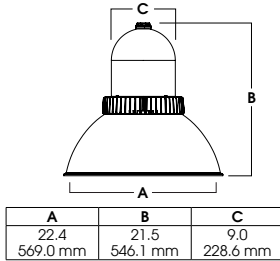

PRISMATIC

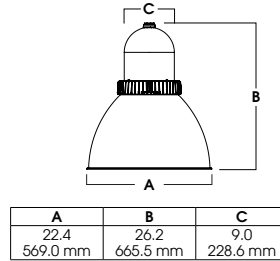

STANDARD FINISHES

MW MATTE WHITE



DMD22/AL22 HM MATTE WHITE

MB MATTE BLACK



DMD22/AL22 HM MATTE BLACK

PT PLATINUM SILVER



DMD22/AL22 HM PLATINUM SILVER

MOUNTING TYPES

HM / AT / PM HANG STRAIGHT / ALL THREAD / PENDANT



DMD22/AL22 SHOWN WITH PM

CD CORD / CABLE MOUNT



DMD22/AL22 SHOWN WITH CD

HC HOOK CORD



DMD22/AL22 SHOWN WITH HC

NM NO MOUNT



DMD22/AL22 SHOWN WITH NM

22" ALUMINUM

DMD SERIES / PHOTOMETRIC DATA



DMD22GZ 240L 35K DX AL22 MWI MW

CANDLEPOWER CURVE TEST SP-01001

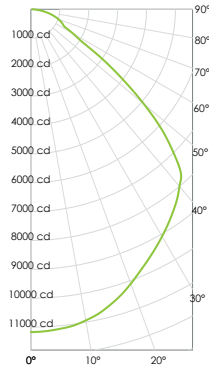

Delivered Lumens: **24,229**
Luminaire Watts: **180**
LER: **134.61**

INTENSITY CANDELA 0° AZIMUTH

0.00°	11,173
0.00°	11,173
5.00°	11,110
10.00°	10,936
15.00°	10,594
20.00°	10,109
30.00°	9,078
40.00°	7,998
50.00°	5,108
60.00°	1,688
70.00°	1,015
80.00°	486
90.00°	40

CP at 0deg (Nadir): **11,173**
CRI: **80**

ZONAL LUMENS

0° - 10°	1,073	4%
0° - 20°	4,064	17%
0° - 30°	8,503	35%
0° - 40°	13,920	57%
0° - 60°	21,983	91%
0° - 80°	23,947	99%
0° - 90°	24,196	100%
Total	24,229	100%

SINGLE UNIT: PERFORMANCE INITIAL FOOTCANDLES BASED ON IES BEAM ANGLE

Mounting Height AFF	FC at Center on Floor	Beam Diameter	FC at Beam Edge
10.0'	112 fc	22.9'	16 fc
12.0'	78 fc	27.5'	11 fc
14.0'	57 fc	32.0'	8 fc
16.0'	44 fc	36.6'	6 fc
20.0'	28 fc	45.8'	4 fc
24.0'	19 fc	54.9'	3 fc
28.0'	14 fc	64.1'	2 fc
32.0'	11 fc	73.2'	2 fc

Beam Angle: **97.68**
Spacing Ratio: **1.21**

MULTIPLE UNITS: PERFORMANCE 80/50/20% REFLECTANCES INITIAL FOOTCANDLES AND WATTS PER SQUARE FOOT

Ceiling Height	Fixture Spacing	RCR 2		RCR 4	
		FC +	W/Sq. Ft.	FC +	W/Sq. Ft.
22'	14'	93	0.75	108	1.08
26'	18'	59	0.47	68	0.68
32'	22'	49	0.40	40	0.40
Delivered Illuminance Rating: (DIR)		124 FC per W/Sq. Ft.		100 FC per W/Sq. Ft.	
4' Suspension Length Square rooms used for multiple units: - RCR 2: Length & Width = Ceiling Ht. - 6.5' x 5.00 - RCR 4: Length & Width = Ceiling Ht. - 6.5' x 2.50 + Average Footcandles at 2.5' Above Floor					

Lumen Multiplier: **N/A, only 240L tested**
CCT Multiplier: **27K x 0.95, 30K x 0.97, 40K x 1.03**

22" PRISMATIC

DMD SERIES / PHOTOMETRIC DATA



DMD22GZ 240L 35K DX DF22

CANDLEPOWER CURVE TEST SP-01003

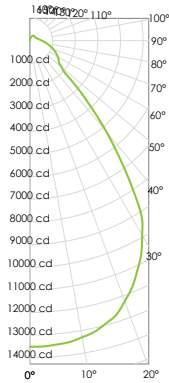

Delivered Lumens: **23,588**
Luminaire Watts: **180**
LER: **131.04**

INTENSITY CANDELA 0° AZIMUTH

Beam Angle (°)	Intensity (cd)
0.00°	13,514
20.00°	12,245
40.00°	5,268
60.00°	1,419
80.00°	778
90.00°	530
100.00°	394
110.00°	320
120.00°	284
140.00°	278
160.00°	179
180.00°	8

CP at 0deg (Nadir): **13,514**
CRI: **80**

ZONAL LUMENS

Beam Angle Range (°)	Lumens	Percentage
0° - 10°	1,300	6%
0° - 20°	4,937	21%
0° - 30°	10,074	43%
0° - 40°	14,881	63%
0° - 60°	18,717	79%
0° - 80°	20,948	89%
0° - 90°	21,651	92%
Total	23,588	100%

SINGLE UNIT: PERFORMANCE INITIAL FOOTCANDLES BASED ON IES BEAM ANGLE

Mounting Height AFF	FC at Center on Floor
10.0'	135 fc
12.0'	94 fc
14.0'	69 fc
16.0'	53 fc
20.0'	34 fc
24.0'	23 fc
28.0'	17 fc
32.0'	13 fc

MULTIPLE UNITS: PERFORMANCE 80/50/20% REFLECTANCES INITIAL FOOTCANDLES AND WATTS PER SQUARE FOOT

Ceiling Height	Fixture Spacing	RCR 2		RCR 4	
		FC +	W/Sq. Ft.	FC +	W/Sq. Ft.
22'	14'	87	0.75	104	1.08
26'	18'	55	0.47	66	0.68
32'	22'	47	0.40	39	0.40
Delivered Illuminance Rating: (DIR)		117 FC per W/Sq. Ft.		97 FC per W/Sq. Ft.	
4' Suspension Length Square rooms used for multiple units: - RCR 2: Length & Width = Ceiling Ht. - 6.5' x 5.00 - RCR 4: Length & Width = Ceiling Ht. - 6.5' x 2.50 + Average Footcandles at 2.5' Above Floor					

Lumen Multiplier: **N/A, only 240L available**
CCT Multiplier: **27K x 0.95, 30K x 0.97, 40K x 1.03**

MOUNTING & ACCESSORIES

SOME OPTIONS NOT AVAILABLE ON ALL FIXTURES. CONSULT SPECIFICATION SHEETS. SEE INDIVIDUAL SPECIFICATION SHEETS OR CONSULT FACTORY FOR ADDITIONAL INFORMATION. NOTE: THIS IS TYPICAL OF RLM SPECIFICATION FOR MOUNTING. INDIVIDUAL FIXTURES OR PROJECTS MAY HAVE SPECIALIZED REQUIREMENTS.



ADDITIONS

FS - FUSING

Slow blow type fuse protects fixture against voltage surges. Factory installed.



SAFETY CABLE OPTIONS

SC1 - SAFETY CABLE

1/16" stainless steel safety cable for added support. Standard kit is 18" and double barrel locks are provided. Approved for California seismic requirements. Rated at 50 lbs.



SC2 - SAFETY CABLE

1/16" Stainless steel cable holds door to fixture

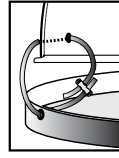

MOUNTING TYPES

HM* HANG STRAIGHT

45° SWIVEL 5/8" OD STEM - 3/8" IP

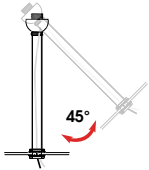

ORDER: **HM** (Length)
SPECIFY LENGTH:

- HM3 - 3" HM24 - 24"
- HM6 - 6" HM36 - 36"
- HM12 - 12" HM48 - 48"
- HM18 - 18" HM72 - 72"
- HMLC(XX)**
Custom Length
(Specify in Inches)

PM* RIGID PENDANT MOUNT

RIGID 5/8" OD STEM - 3/8" IP

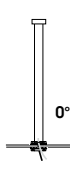

ORDER: **PM** (Length)
SPECIFY LENGTH:

- PM3 - 3" PM24 - 24"
- PM6 - 6" PM36 - 36"
- PM12 - 12" PM48 - 48"
- PM18 - 18" PM72 - 72"
- PMLC(XX)**
Custom Length
(Specify in Inches)

AT** HANG STRAIGHT ALL THREAD

45° SWIVEL 5/8" OD STEM - 1/4" IP

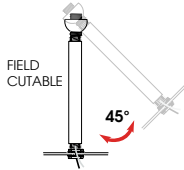

ORDER: **AT** (Length)
SPECIFY LENGTH:

- AT12 - 12"
- AT24 - 24"
- AT36 - 36"

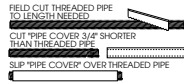

CD CORD / CABLE MOUNT

SJ CORD WITH 1/16 SS CABLE



ORDER: **CD** (Length)
SPECIFY LENGTH:

- CD36 - 36"
- CD72 - 72"
- CD144 - 144"
- CDLC(XX)**
Custom Length
(Specify in Inches)

HC HOOK & CORD FOR INDEPENDENT MOUNTING

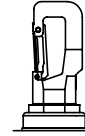

ORDER: **HC** (Length)
SPECIFY LENGTH:

- HC36 - 36"
- HC72 - 72"
- HC144 - 144"
- HCLC(XX)**
Custom Length
(Specify in Inches)

NMX 1/2" NPT Hub 3/4" NPT Hub FOR INDEPENDENT MOUNTING



ORDER: **NMX** (Length)
SPECIFY LENGTH:
NM2(12) - 12" Leads are Standard
NM3(12) - 12" Leads are Standard
NMXLC(XX)
Custom Length
(Specify in Inches)

*MAXIMUM ONE PIECE STEM LENGTH IS 72". **MAXIMUM ONE PIECE STEM LENGTH IS 36". LONGER LENGTHS ARE POSSIBLE USING MULTIPLE STEMS AND COUPLERS.

REMOTE EMERGENCY BATTERY OPTIONS

EMRM* - 7W REMOTE EMERGENCY BATTERY (50' MAX)

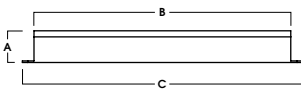

A	B	C
1.3	12.6	13.0

EMEN* - 7W REMOTE EMERGENCY BATTERY WITH ENCLOSURE (50' MAX)

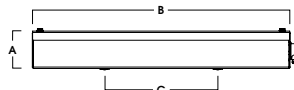

A	B	C
2.0	17.0	6.2

*OTHER EM BATTERY SIZES AVAILABLE. CONSULT FACTORY

COLOR OPTIONS - POWDER COAT PAINT FINISHES

NOTE: NO PRINTED IMAGE CAN EQUAL THE EXACT COLOR OF FINISH ON METAL.
SEE INDIVIDUAL SPECIFICATION SHEETS OR CONSULT FACTORY FOR ADDITIONAL INFORMATION.



STANDARD CORD / STEM / CANOPY FINISHES

FIXTURE COLOR	STANDARD CORD COLOR	STANDARD CANOPY / STEM COLOR
Matte White, Textured White	Matte White	Matte White
Gloss White	Matte White	Gloss White
Matte Black, Gloss Black, Textured Black	Matte Black	Matte Black
All Others	Matte Black	Same Color as Fixture
Custom Color	Contact Factory	Contact Factory

PAINT TIMES

TIER	COST	AVERAGE PAINT TIME*
Tier 1 - Standard Finishes	\$	⌚
Tier 2 - Typical Finishes	\$\$	⌚⌚
Custom Color	Contact Factory	Contact Factory

*CONTACT FACTORY FOR SPECIFIC PRODUCT LEAD TIMES

TIER 1 - STANDARD FINISHES

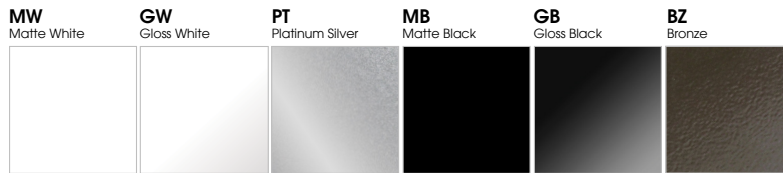

TIER 2 - TYPICAL FINISHES



CUSTOM COLOR FINISHES

CONTACT FACTORY

CC
Custom Color



*UNAVAILABLE FOR WET LOCATION