

**FEATURES:**

- Spectrum Lighting offers a series of "Goof Rings" to cover large or uneven ceiling openings.
- Goof rings are designed to fit standard Spectrum reflectors. Recess fits reflector flange (seats reflector flush)
- 1/4" return cups to seat to ceiling (eliminate light leaks).
- Custom size I.D. or O.D. for existing work (square or round) available. Consult factory.
- Material: .050 1100-0 aluminum.
- Finish: matte white paint (MW), Soft Glow Alzak (SG), or other choices, consult factory.

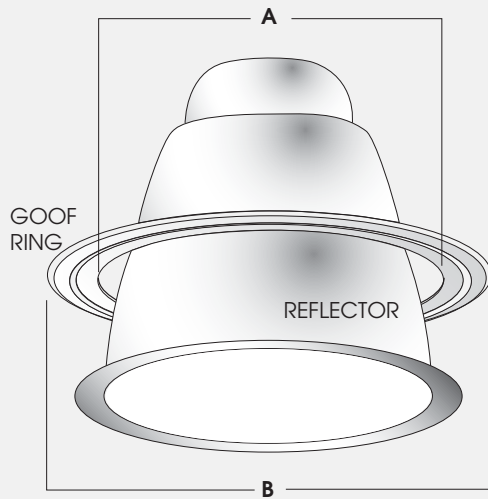

Dimensions shown are nominal. Spectrum Lighting is continually improving products and reserves the right to make changes that will not alter performance or appearance.

**"GOOF RING" SERIES  
OPTIONS AND  
INSTALLATION**

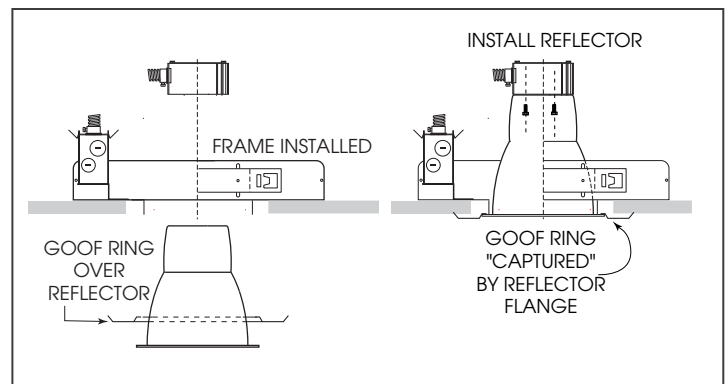
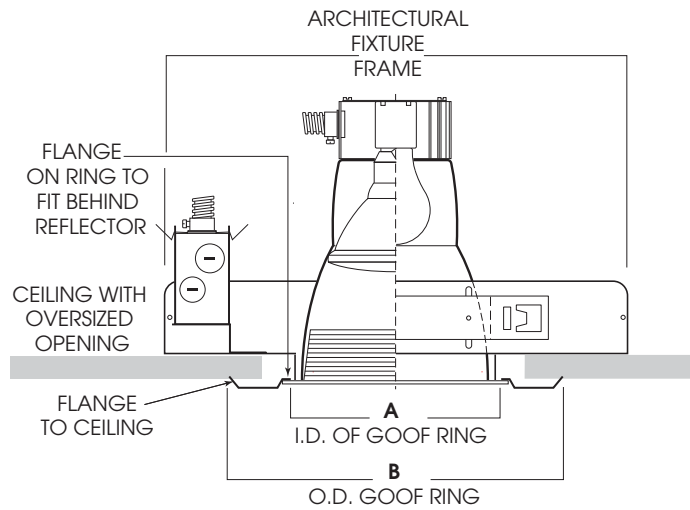

SERIES NO.	APERTURE	GOOF RING I.D. <sup>A</sup>	GOOF RING O.D. <sup>B</sup>	FINISH
GR4-	4.0	4.25 / 107.9mm	6.88 / 174.6mm	<b>MW</b> - MatteWhite (Standard) <b>SG</b> - Soft Glow <b>PF</b> - Polished Flange
GR5-	5.0	5.06 / 128.6 mm	7.56 / 192.0 mm	
GR7-	7.0	6.75 / 171.4 mm	9.06 / 230.2 mm	
GR7L-	7.0	6.75 / 171.4 mm	10.56 / 268.2 mm	
GR8-	8.0	7.75 / 196.8 mm	10.62 / 269.8 mm	
GR8L-	8.0	7.75 / 196.8 mm	12.88 / 327.6 mm	
GR9-	9.0	9.5 / 241.3 mm	12.5 / 317.5 mm	Other finishes available- Consult Factory
GR10H-	10.0	10.12 / 257.2 mm	14.0 / 355.6 mm	
GR10V-	10.0	10.12 / 257.2 mm	14.0 / 355.6mm	
GR*:	CUSTOM:	CUSTOM:	CUSTOM:	
<b>GR8L</b>				



994 Jefferson Street . Fall River, MA 02721 . 508.678.2303 FAX 508.678.2260