

4" ROUND LED ADJUSTABLE TUNABLE COLOR (HUE) LU SERIES / 1800 LUMENS MAX LED

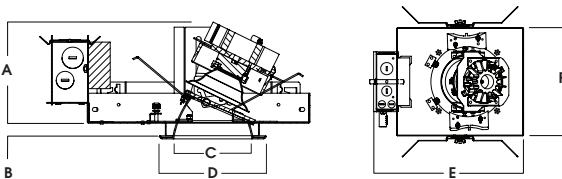

A	B	C	D	E	F
6.1 154.9 mm	.625 15.2 mm	4.0 101.6 mm	5.4 137.16 mm	14.7 373.4 mm	9.5 241.3 mm

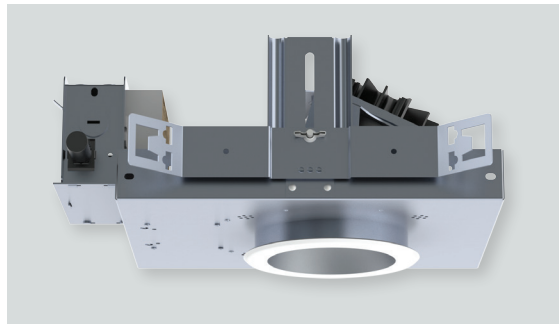
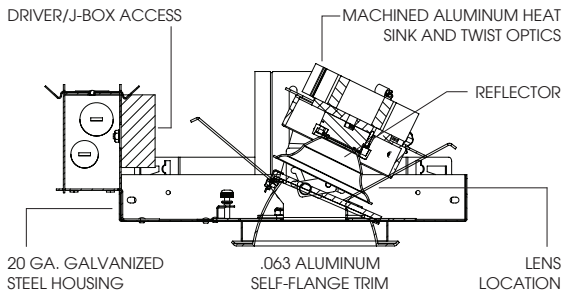
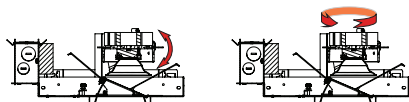

LED MODULE TILTS AND LOCKS TO 35° AND ROTATES AND LOCKS 360° WHILE MAINTAINING CENTER BEAM FOCUS

RAFO4LEDLU - TRIM FLANGE / NON IC RATED

APPLICATION

4" Round LU LED adjustable platform with Tunable color (HUE) LED system. System can be programmed for scenes or set for manual control. Adjusts to over 300,000 colors as well as 1600K-6000K white light.

FEATURES

Two-stage optical system for smooth light distribution and focus control. Quick change LED module with interchangeable optics for job site adjustment and fixture maintenance. Shallow plenum design. Tool-less driver and j-box access. Posi-lock trim retention torsion springs. Integral 0.625" collar with deep ceiling option for up to 2" thick ceiling (PR).

TRIM FINISH

A variety of architectural powdercoat and anodized finishes are available. Matte White self-flange is standard.

ELECTRONICS

LED system features LED module with proprietary Tunable color (HUE) technology that provides consistent, stable color with CCT control of +/- 100K over life of the light engine. Base CRI is 90 with <2 MacAdam Ellipse binning. Variety of dimming controls (by Others).

CONSTRUCTION

Housing/frame constructed of #20 ga. galvanized steel to resist corrosion. Self-flanged one piece trim spun from 0.063" thick high purity aluminum and finished to specification.

CODE COMPLIANCE

ARRA Compliant. Non-IC rated. ETL listed for damp locations. Optional Wet location. Manufactured and tested to UL standards No. 1598/8750.

WATTAGE TO LUMENS UPDATE

CURRENT PART NUMBER EXAMPLE	PREVIOUS PART NUMBER EXAMPLE	SOURCE LUMENS ¹	SYSTEM WATTS
RAFO4LEDLU12L	RAFO4LEDLU11W	1250	20
RAFO4LEDLU14L	N/A	1400	25
RAFO4LEDLU16L	RAFO4LEDLU15W	1600	32
RAFO4LEDLU18L	RAFO4LEDLU20W	1800	32

RECESSED HOUSING SPECIFICATION

SERIES	LUMENS ¹	CCT / HUE	BEAM	CONTROL / VOLTAGE ²	OPTIONS
RAFO4LEDLU	12L	1250 Lm	40CMX	40K-16K	ND 20°
	14L	1400 Lm	60CMX	60K-27K	MD 30°
	16L	1600 Lm			WD 40°
	18L	1800 Lm			XW 50°
					DU ³
					DL3E ³
					DMX ³
					BT ³
				1% 0-10V Dimming	
				ECO System Dimming	
				DMX Control Dimming	
				Bluetooth Control Dimming	
				1 120v	BH27 ⁴
				2 277v	H12
					H06
					CB24
					EB
					PR ⁵
					REMLU ³

LED TRIM SPECIFICATION

TRIM / FINISH ⁶	TRIM OPTIONS ¹⁰
RA4F ⁷	SOX ¹¹
SG ⁸	Micro Prism Solite™ Lens
HZ	Haze Full Diffuse
MW	Matte White
MB	Matte Black
AC	Anodic Champagne
AS	Anodic Sapphire
PT	Platinum Silver
OB	Oil Rubbed Bronze
CH	Charcoal
AS	Anodic Sapphire
AM	Anodic Malachite
SN	Sun Gold
CO	Copper Metallic
GH	Graphite
AMB	Anti Microbial Finish
CC	Custom Color
PF ⁹	Polished Flange
	PGX ¹¹
	GLX
	FGX
	SOW
	OB
	PGW
	GLW
	FGW

EXAMPLE: RAFO4LEDLU12L40CMXMDDMX1H12REMLU/RA4FSGSOX

NOTES:

1 Nominal Source Lumens 2 Contact Factory for Additional Options 3 Refer to CMX Controls Page 4 Standard Bar Hangers 5 Contact Factory 6 Contact Factory for Special Finishes 7 "F" Indicates Self-Flange Trim, Matte White Standard 8 Standard Finish 9 Flange and Reflector Same Finish 10 Consult Factory for Special Lenses/Louvers 11 Standard Lens

lumenetix



Dimensions shown are nominal. Spectrum Lighting is continually improving products and reserves the right to make changes that will not alter performance or appearance with or without written notice.



PROJECT:	TYPE:
CAT. NO.:	



RECESSED CTM OPTIONS



DU1 / DU2 - Fixture can be operated by the following 3 methods (Does Not Require DCA).

1. Use with REMLU option for wireless control of dimming and color tuning. (See Figure 3)
2. Use with 0-10V controller and REMLU option for dimming control and presetting color levels with REMLU. (See Figure 4)
3. Use with 0-10V controller, plus CCT controller & REMLU option for separate dimming control, separate color tuning control & presetting color levels with REMLU. (See Figure 5 & 5B)

DL3E1 / DL3E2 - For control of dimming and color tuning with Eco System controller (Supplied by Lutron) Fixture supplied with DCA¹. (See Figure 1)

DMX1 / DMX2 - For control of dimming and color tuning with minimum 4 channel DMX controller (Supplied by Others) Fixture supplied with DCA¹. (See Figure 2 & 2B)

BT1 / BT2 - For control of dimming and color tuning with Bluetooth app (IOS Only) (Download by Others) Fixture supplied with DCA¹. (See Figure 2)

REMLU - is a remote wireless commissioning tool that allows complete control of fixture's Dimming, Color Saturation and Hue. Operates on Zigbee Platform @ 2.4GHz band. Maximum of 60 fixtures can be controlled with 5 separate present lighting scenes. Refer to installation instructions for wiring diagrams and operations.

Consult Factory for additional questions and information.

NOTES:

¹ DCA - is a digital control adapter which enables fixtures powered by standard lighting protocols to be converted to a digital link.

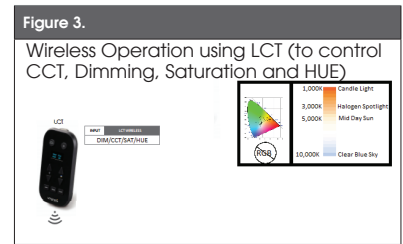
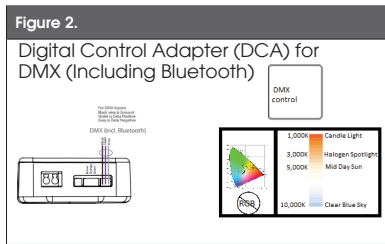
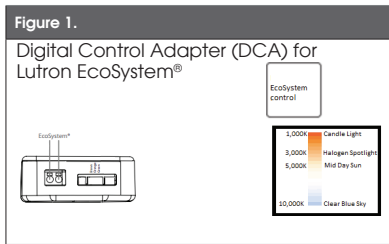

**Requires araya Tunable Color iOS APP

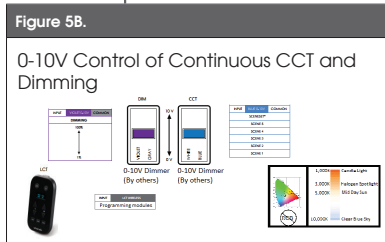
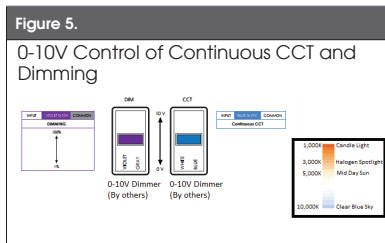
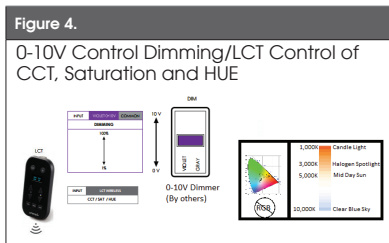
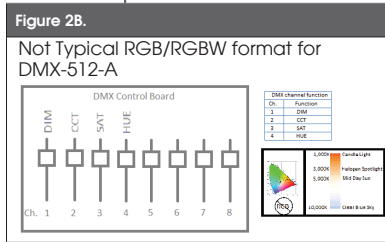

Dimensions shown are nominal. Spectrum Lighting is continually improving products and reserves the right to make changes that will not alter performance or appearance with or without written notice.



PROJECT:	TYPE:
CAT. NO.:	

