



METAL HALIDE GALLERY

Metal Halide technology has rapidly progressed with PAR, T-4 and T-6 lamps being offered in 20 Watt (T-4) up to 150 Watt (PAR-38). **EFEX** has produced this series of metal halide down-lights to compliment these new lamps. The T-4 and T-6 fixtures offer interchangeable focusing reflectors for Narrow, Medium or Wide/Flood beam spread. In addition Spectrum finishes reflectors in optional wheat and gold to warm the CRI of these lamps. The 20 and 39 watt lamps are optimum for retail applications where watts per square foot mandates exist. Design and lighting performance do not have to be compromised. Housings are aluminum for maximum heat dissipation and painted in matte black to eliminate stray glare. All ballasts and wiring are accessible through ceiling aperture. Ballasts are all electronic and thermally protected. Fixtures are also offered with Wet location (WL) option.



4" APERTURE - PAR 20 METAL HALIDE

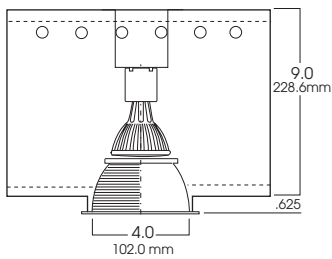

SGD4MH-4" PAR20 DOWNLIGHT

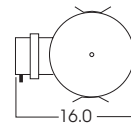
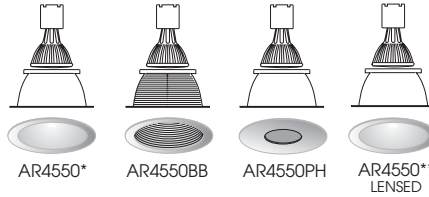

HOUSING:
Ø11.5 x 16.0 OVERALL

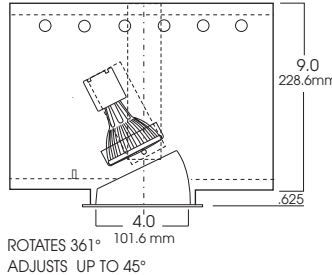

SGA4MH-4" ADJUSTABLE PAR20 DOWNLIGHT

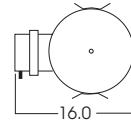
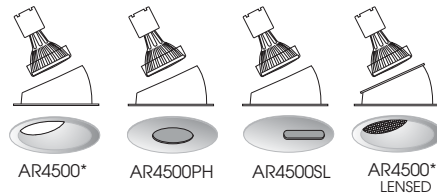

HOUSING:
Ø11.5 x 16.0 OVERALL

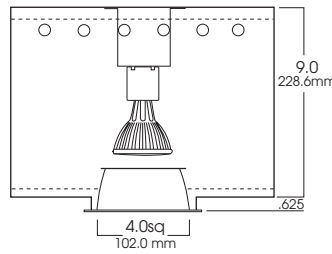

4" SQUARE APERTURE- PAR20METAL HALIDE SGD4SQMH-4" SQUARE PAR20 DOWNLIGHT

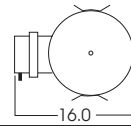
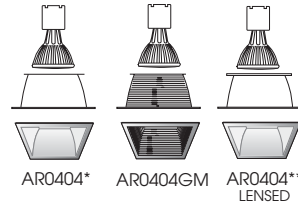

HOUSING:
Ø11.5 x 16.0 OVERALL

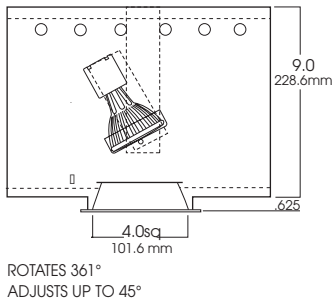

SGA4SQMH-4" SQUARE ADJUSTABLE PAR DOWNLIGHT

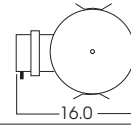
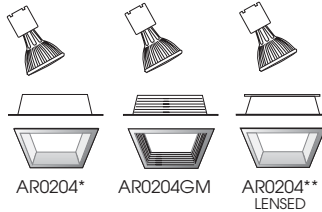

HOUSING:
Ø11.5 x 16.0 OVERALL

SERIES	LAMP TYPE	WATTS	VOLTAGE	OPTIONS	REFLECTOR /	FINISH
SGD4MH- 4" Metal Halide PAR Downlight	PAR20	35/39 50	E1- 120 Volt Electronic E2- 277 Volt Electronic	FS- Fusing **- Lens- See Page 27 for available lenses BH27- 27" Mounting Bars CP- CCEA SP- Spread Lens	AR4550- PAR20 Downlight AR4500- PAR20 Adjustable AR4500SLWW- PAR 20 Spread Lens Wall Wash AR0404- Square PAR20 Downlight AR0204- Square PAR20 Adjustable	CL - Clear Alzak SG - Soft Glow * - Colored Alzak *Specify color WF - White Flange BB - Black Micro Baffle WB - White Micro Baffle GM - Grooved Metallic WH - Painted White BK - Painted Black SEE PAGE 27 FOR COLOR OPTIONS
EXAMPLE: SGD4MH	PAR20	50	E1	BH27	AR4550CL	



4" APERTURE-T4 METAL HALIDE-UV PROTECTED

4" APERTURE T-4 METAL HALIDE-UV PROTECTED

NOTE: GLASS LENS INCLUDED WITH ALL T-4 LAMPS

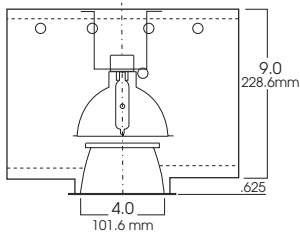

SGD4MH-4" T4 METAL HALIDE DOWNLIGHT - UV PROTECTED

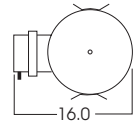
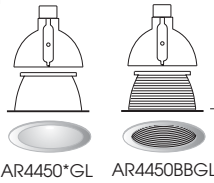

HOUSING
Ø11.5 X 16.0 OVERALL

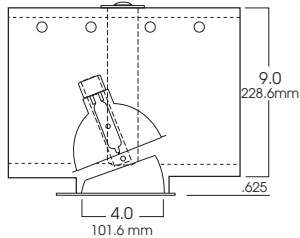

SGA4MH-4" T4 METAL HALIDE ADJUSTABLE - UV PROTECTED

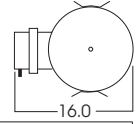
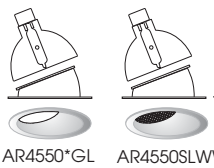

HOUSING
Ø11.5 X 16.0 OVERALL

ROTATES 361°
ADJUSTS UP TO 37°

4" SQUARE APERTURE T-4 METAL HALIDE-UV PROTECTED

NOTE: GLASS LENS INCLUDED WITH ALL T-4 LAMPS

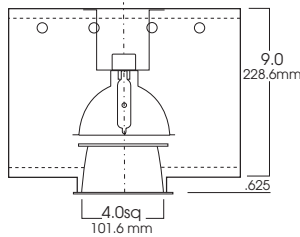

SGD4SQMH-4" SQ. T-4 METAL HALIDE DOWNLIGHT - UV PROTECTED

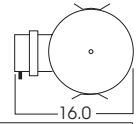
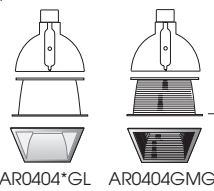

HOUSING
Ø11.5 X 16.0 OVERALL

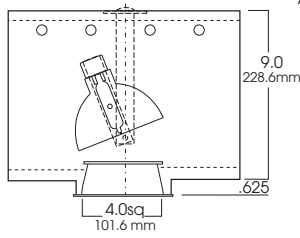

SGA4SQMH-4" SQ. T-4 METAL HALIDE ADJ. - UV PROTECTED

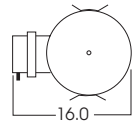
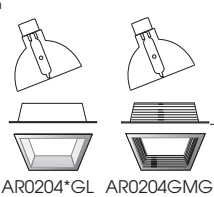

HOUSING
Ø11.5 X 16.0 OVERALL

ROTATES 361°
ADJUSTS UP TO 37°

SERIES	LAMP	WATTS	VOLTAGE	OUTPUT	OPTIONS	UPPER REFLECTOR	CONE/ FINISH
SGD4MH- 4" T-4 MH Downlight	T-4	20	E1-120 Volt	ND- Narrow Distribution	FS- Fusing GL- Tempered	URSG- Soft Glow	AR4450- 4" Downlight
SGA4MH- 4" T-4 MH Adjustable		35/39	E2- 277 Volt Electronic	MD- Medium Distribution	TR- Top Re- lamping	URWE- Wheat Alzak	AR4550- 4" Adjustable
SGD4SQMH- 4" Sq. T-4 MH Downlight		50	E2- 277 Volt Electronic	WD- Wide Distribution	BH27- 27" Mounting Bars	URGO- Gold Alzak	AR4550SLWW- T-4 Spread Lens Wall Wash
SGA4SQMH- 4" Sq. T-4 MH Adjustable					TBC- T-Bar Clips GS- Gasket	UR*- Other *specify color	AR0404- 4" Square Downlight
							AR0204- 4" Square Adjustable
							CLGL - Clear Alzak SGGL - Soft Glow *GL - Colored Alzak *Specify color PF - Polished Flange BBGL - Black Micro Baffle WBGL - White Micro Baffle GMGL - Grooved Metalic WHGL - Painted White BKGL - Painted Black SEE PAGE 27 FOR COLOR OPTIONS All fixtures have lens included

EXAMPLE: **SGD4MH** **T4** **50** **E1** **MD** **BH27** **URWE** **AR4450CLGL**





5" APERTURE PAR METAL HALIDE

5" APERTURE PAR 30 METAL HALIDE

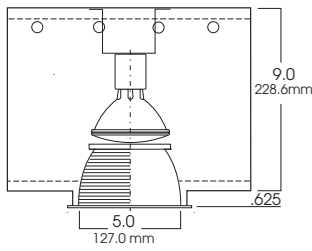

SGD5MH 5" APERTURE PAR30 METAL HALIDE DOWNLIGHT

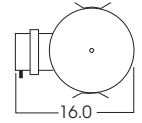
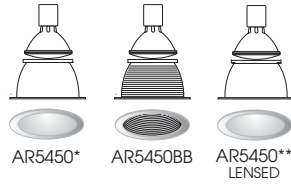

HOUSING
Ø11.5 X 16.0 OVERALL

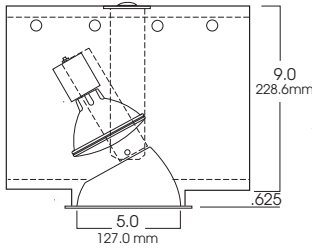

SGA5MH 5" APERTURE PAR30 METAL HALIDE ADJUSTABLE

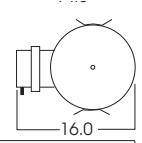
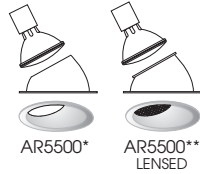

HOUSING
Ø11.5 X 16.0 OVERALL

ROTATES 361°
ADJUSTS TO 37°

SERIES	LAMP TYPE	WATTS	VOLTAGE	OPTIONS	CONE/ FINISH
SGD5MH- 5" Metal Halide PAR Downlight	PAR30	35/39 70	E1-120 Volt Electronic E2-277 Volt Electronic	FS- Fusing GL- Tempered Glass Lens TR- Top Re-lamping BH27- 27" Mounting Bars TBC- T-Bar Clips GS- Gasket CP- CCEA	AR5450- Downlight AR5500- Wall Wash AR5500SLWW- Spread Lensed Wall Wash CL - Clear Alzak SG - Soft Glow * - Colored Alzak *Specify color WF - White Flange BB - Black Micro Baffle WB - White Micro Baffle WH - Painted White BK - Painted Black SEE PAGE 27 FOR COLOR OPTIONS
EXAMPLE: SGD5MH	PAR30	50	120	BH27	AR5450CL

5" APERTURE-T4-T6 METAL HALIDE - UV PROTECTED



5" APERTURE T-4/T-6 METAL HALIDE-UV PROTECTED
 NOTE: GLASS LENS INCLUDED WITH ALL T-4 & T-6 LAMPS

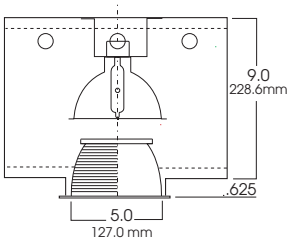

SGD5MH -5" T4 /T6METAL HALIDE-UV PROTECTED

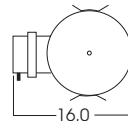
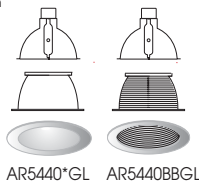

HOUSING:
 Ø 11.5 X 16.0 OVERALL

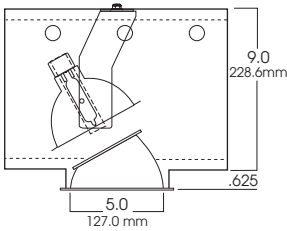

SGA5MH -5" T4 /T6METAL HALIDE-UV PROTECTED

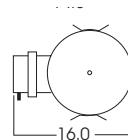
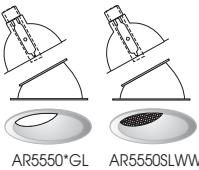

HOUSING:
 Ø 11.5 X16.0 OVERALL

ROTATES 361°
 ADJUSTS TO 37°

SERIES	LAMP	WATTS	VOLTAGE	OUTPUT	OPTIONS	UPPER REFLECTOR	CONE/ FINISH	
SGD5MH- 5" T-4 MH Downlight	T-4	20	E1-120 Volt	ND- Narrow Distribution	FS- Fusing GL- Tempered Glass Lens	URSG- Soft Glow (standard)	AR5440- 5" Downlight AR5550- 5" Adjustable	
SGA5MH- 5" T-4 MH Adjustable	T-6	35/39 50	E2- 277 Volt Electronic	MD- Medium Distribution WD- Wide Distribution	TR- Top Re- lamping BH27- 27" Mounting Bars TBC- T-Bar Clips GS- Gasket CP- CCEA	URWE- Wheat Alzak URGO- Gold Alzak UR* - Other *specify color	AR5550SLWW- T-4 Spread Lens Wall Wash	
							CLGL - Clear Alzak SGGL - Soft Glow *GL - Colored Alzak *Specify color PF- Polished Flange BBGL - Black Micro Baffle WBGL - White Micro Baffle GMGL - Grooved Metalic WHGL - Painted White BKGL - Painted Black SEE PAGE 27 FOR COLOR OPTIONS All fixtures have lens included	
EXAMPLE:	SGD5MH	T4	50	E1	MD	BH27	URWE	AR5440CLGL



7" APERTURE T-4/T-6 METAL HALIDE - UV PROTECTED

NOTE: GLASS LENS INCLUDED WITH ALL T-4 & T-6 LAMPS

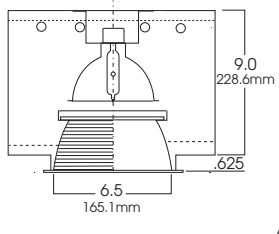

SGD7MH -7" T4 /T6 METAL HALIDE DOWNLIGHT - UV PROTECTED

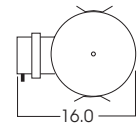
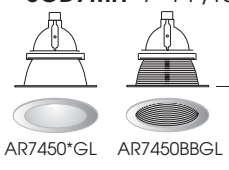

HOUSING:
Ø11.5 X16.0 OVERALL

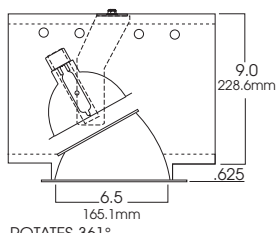

SGA7MH -7" T4 /T6 METAL HALIDE ADJUSTABLE - UV PROTECTED

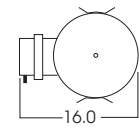
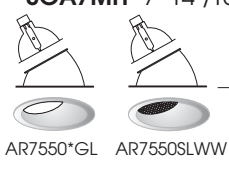

HOUSING:
Ø11.5 X 16.0 OVERALL

ROTATES 361°
ADJUSTS TO 37°

6" SQUARE APERTURE T-4/T-6 METAL HALIDE-UV PROTECTED

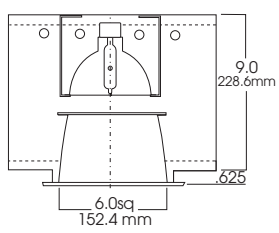

SGD6SQMH -6" SQ. T4/T6 METAL HALIDE DOWNLIGHT - UV PROTECTED

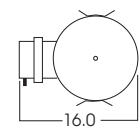
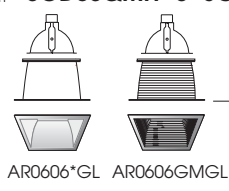

HOUSING:
Ø 11.5 X 16.0 OVERALL

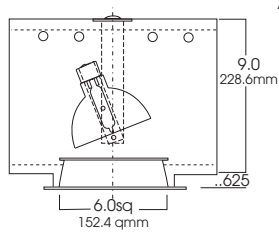

SGA6SQMH -6" SQ. T4/T6 METAL HALIDE ADJUSTABLE - UV PROTECTED

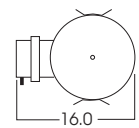
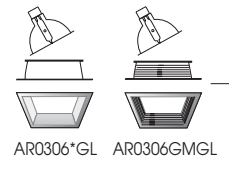

HOUSING:
Ø11.5 X16.0 OVERALL

ROTATES 361°
ADJUSTS TO 37°

SERIES	LAMP	WATTS	VOLTAGE	OUTPUT	OPTIONS	UPPER REFLECTOR	CONE/ FINISH
SGD6MH- 6" T-4/T-6 MH Downlight	T-4	35/39	E1-120 Volt	ND- Narrow Distribution	FS- Fusing **- Lens-See Page 27 for available lenses	URSG- Soft Glow (standard)	AR7450- 6" Downlight AR7550- 6" Adjustable AR7550SLWW- T-4
SGA6MH- 6" T-4/T-6 MH Adjustable	T-6	50 70 100 150	E2-277 Volt Electronic	MD- Medium Distribution WD- Wide Distribution	TR- Top Re- lamping BH27- 27" Mounting Bars TBC- T-Bar Clips GS- Gasket	URWE- Wheat Alzak URGO- Gold Alzak UR* - Other *specify color	CLGL- Clear Alzak SGGL- Soft Glow *GL- Colored Alzak *Specify color PF- Polished Flange BBGL- Black Micro Baffle WBGL- White Micro Baffle GMGL- Grooved Metallic WHGL- Painted White BKGL- Painted Black SEE PAGE 27 FOR COLOR OPTIONS All fixtures have lens included
SGD6SQMH- 6" Sq. T-4/T-6 MH Downlight							
SGA6SQMH- 6" Sq. T-4/T-6 MH Adjustable							
EXAMPLE: SGD6MH	T4	150	E1	MD	BH27	URSG	AR7450CLGL

6" SQUARE APERTURE PAR METAL HALIDE



6" SQUARE APERTURE PAR METAL HALIDE

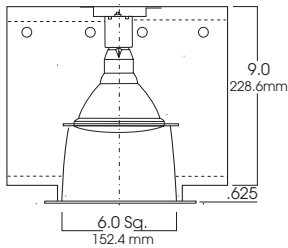

SGD6SQMH- 6" SQUARE PAR 30/PAR38 METAL HALIDE DOWNLIGHT

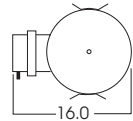
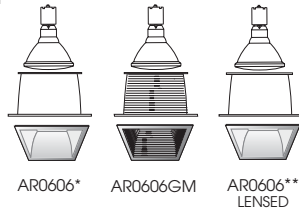

HOUSING:
Ø11.5, 16.0 OVERALL

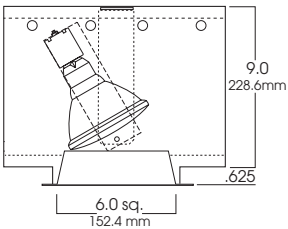

SGA6SQMH- 6" SQUARE PAR 30/PAR38 METAL HALIDE ADJUSTABLE

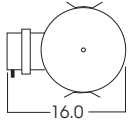
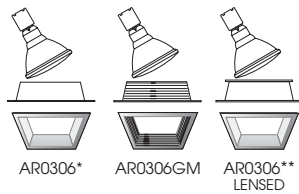

HOUSING:
Ø11.5, 16.0 OVERALL

ROTATES 361°
ADJUSTS UP TO 37°

SERIES	LAMP TYPE	WATTS	VOLTAGE	OPTIONS	CONE/ FINISH
SGD6SQMH- 6" Sq. PAR Metal Halide Downlight	PAR30 PAR38	35 50 100 150	E1-120 Volt Electronic E2- 277 Volt Electronic	FS- Fusing GL- Tempered Glass Lens TR- Top Re-lamping BH27- 27" Mounting Bars TBC- T-Bar Clips GS- Gasket CP- CCEA LN30- Lens Holder PAR 30 LN38- Lens Holder PAR 38	AR0606- Downlight AR0306- Adjustable Downlight CL - Clear Alzak SG - Soft Glow * - Colored Alzak *Specify color WF - White Flange GM - Grooved Metallic WH - Painted White BK - Painted Black SEE PAGE 27 FOR COLOR OPTIONS
EXAMPLE: SGD6SQMH	PAR38	50	E1	BH27	AR0606CL



7" APERTURE - PAR METAL HALIDE

7" APERTURE DOWNLIGHT PAR METAL HALIDE

SGD7MH-7" METAL HALIDE DOWNLIGHT

HOUSING: Ø 11.5 X 16.0 OVERALL

7" APERTURE SPREAD LENSED WALL WASH METAL HALIDE

SGA7MH-7" METAL HALIDE PAR ADJUSTABLE

ROTATES 361°
ADJUSTS UP TO 37°

HOUSING: Ø 11.5 X 16.0 OVERALL

7" APERTURE SPREAD LENSED WALL WASH METAL HALIDE

SGL7MH-7" METAL HALIDE SPREAD LENSED WALL WASH

ROTATES 361°

HOUSING: Ø 11.5 X 16 OVERALL

SERIES	LAMP TYPE	WATTS	VOLTAGE	OPTIONS	CONE/ FINISH
SGD7MH- 7" Metal Halide Downlight	PAR30 PAR38	35 50 100	E1-120 Volt Electronic E2-277 Volt Electronic	FS- Fusing GL- Tempered Glass Lens TR- Top Re-lamping BH27- 27" Mounting Bars TBC- T-Bar Clips GS- Gasket CP- CCEA LN38- Lens Holder PAR 38	AR7400- Downlight AR7500- Adjustable Downlight AR7900- Lensed Wall Wash CL - Clear Alzak SG - Soft Glow * - Colored Alzak *Specify color WF- White Flange BB - Black Micro Baffle WB - White Micro Baffle WH - Painted White BK - Painted Black SEE PAGE 27 FOR COLOR OPTIONS
SGA7MH- 7" Metal Halide Adjustable Downlight		150			
SGL7MH- 7" Metal Halide Lensed Wall Wash					
EXAMPLE: SGD7MH	PAR38	50	E1	BH27	AR7400CL



SPECIFICATIONS

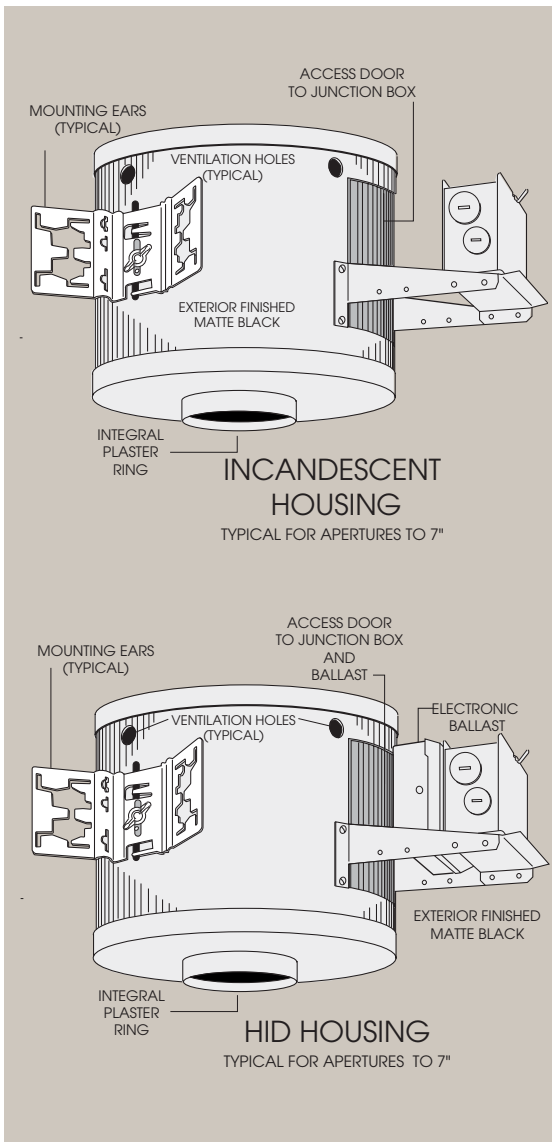

EFEX FIXTURE SPECIFICATIONS

HOUSINGS

- Spectrum **EFEX** housings are constructed of .050 Aluminum for optimum heat dissipation.
- Junction boxes have multiple KO's and are listed for through wiring.
- Fixtures, ballasts and transformers are thermally protected.
- Fixture interiors and components are powder coated matte black to eliminate stray light.
- Plaster ring is integral and will work with 5/8" to 1" thick ceilings standard. Optional plaster rings available up to 4".
- Mounting brackets accept BH27, c-channel, conduit, and will allow up to 4" adjustment.
- All fixtures have top re-lamping option.

ELECTRICAL

- All wiring, ballasts, and transformers are accessible and serviceable through ceiling opening.
- Low voltage fixtures feature electronic 75 watt, 120 volt (277v. option) transformers, thermally protected, and dimmable.
- Magnetic transformers are an option (120 or 277).
- Line voltage PAR incandescent fixtures are wired for 120 volt-standard. A 277 volt step-down transformer is optional.
- HID **EFEX** fixtures feature electronic dual voltage (120/277) ballasts. These are thermally protected.

PHOTOMETRICS

- IES reports available.

LENSES

- All lenses offered are custom cut tempered borosilicate, or soda-lime glass.
- **EFEX** offers a variety of beam smoothing, diffusion, UV, and color filters/lenses to create desired lighting effects.

OPTIONS

- **IC**- Incandescent fixtures may be ordered for use with insulated ceilings. See size and availability chart on page 14
- **WL** -All fixtures may be ordered for wet locations. Individual listings will indicate availability.
- **AT**- Some of the fixtures may be ordered with air-tight configurations - please consult the factory.
- **PF**-Polished Flange- for polished matching flange at ceiling level.
- **PR***- Plaster ring, specify aperture and depth.
- **GR**- Goof ring- specify aperture and diameter of outer edge.

SPECTRUM LIGHTING **EFEX** Series fixtures are crafted with pride in our Fall River, Massachusetts factory. Fixtures are built to UL standard #1598 and tested to ensure a long and maintenance-free operation.

At SPECTRUM we welcome your suggestions and input. Please call 888-77-LIGHT for your local representative. Visit our website www.speclight.com for more lighting solutions.



REFLECTORS

Spectrum Lighting takes pride in manufacturing it's own reflectors. For the **EFEX** Series we have chosen a group of the most popular finishes.

CLEAR finishes appear bright and give the best lamp efficiency. SOFT GLOW finishes are semi-diffuse, appear less bright, and "glow softly", as well as resisting fingerprinting during installation and re-lamping.

Reflectors are formed from one piece .063 thick aluminum with 5/8" white flange. Spectrum Lighting will finish the reflector flange in custom colors as well as match other reflector colors and finishes. Polished flange and narrow flange are available as options

REFLECTOR OPTIONS:

- BB**- Black micro Baffle
- WB** - White micro Baffle
- PF**- Polished Flange



- * Finishes for Bezel Trims:
- SS** - Brushed stainless steel ring
 - WR** - Gloss white ring
 - CR** - Chrome ring
 - BR** - Brass ring



LENSES

SPECIALTY LENSES:	ORDER #
LINEAR SPREAD	#600
GENERAL SPREAD	#673
DIFFUSION	#606
FROST	#100
UV BLOCK	#702
HEX LOUVER	#HEX

COLORED LENSES:	ORDER #
ORANGE	#167
GOLDEN AMBER	#166
LIGHT PEACH	#204
LEMON YELLOW	#101
MEDIUM GREEN	#157
MEDIUM BLUE	#143

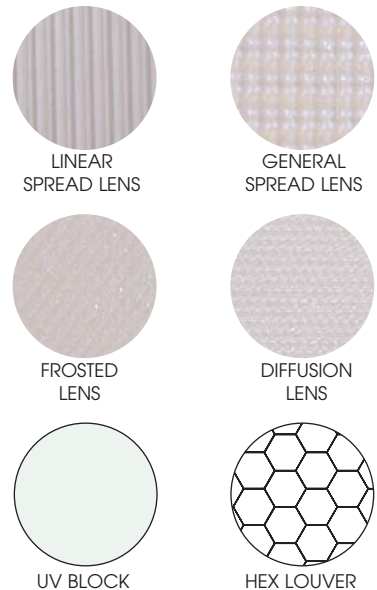

OPTIONAL LENS HOLDERS:	ORDER #
MR16	LN16
PAR20	LN20
PAR30	LN30
PAR38	LN38

Consult the factory for options or the 41 other colored lenses available.