



# SPECTRUM LIGHTING RLM CLASSICS SERIES



# CLASSIC PROFILES

STATUARY  
BRONZE  
FINISH



## DEEP BOWL

Deep bowl profile fits easily into a variety of lighting applications.

DIA	HT	INCANDESCENT	HID	FLUORESCENT
		MODEL NO.	MODEL NO.	MODEL NO.
10.0	9.0	DB1009INC	DB1009MH	DB1009CF
12.0	11.0	DB1211INC	DB1211MH	DB1211CF
14.0	13.0	DB1413INC	DB1413MH	DB1413CF
16.0	15.0	DB1615INC	DB1615MH	DB1615CF
18.0	17.0	DB1817INC	DB1817MH	DB1817CF

BRUSHED  
ALUMINUM



## ESPRESSO PENDANT

Contoured profile with wide top.

DIA	HT	INCANDESCENT	HID	FLUORESCENT
		MODEL NO.	MODEL NO.	MODEL NO.
14.0	14.0	EP1414INC	EP1414MH	EP1414CF

EVERGREEN  
FINISH



## RADIAL WAVE

The Radial Wave's fluted profile is a fine choice for indoor or outdoor uses.

DIA	HT	INCANDESCENT	HID	FLUORESCENT
		MODEL NO.	MODEL NO.	MODEL NO.
12.0	5.0	RW1205INC	RW1205MH	RW1205CF
16.0	6.0	RW1606INC	RW1606MH	RW1606CF
20.0	7.0	RW2007INC	RW2007MH	RW2007CF

BLUE  
STREAK  
FINISH



## OPEN REFLECTOR

Indirect illumination from the open top softens the transition from ceiling to work plane.

DIA	HT	INCANDESCENT	HID	FLUORESCENT
		MODEL NO.	MODEL NO.	MODEL NO.
18.0	18.0	OR1818INC	OR1818MH	OR1818CF

RED  
BARON  
FINISH



## WAREHOUSE SHADE

An industrial profile, this shade works well with all lamp types.

DIA	HT	INCANDESCENT	HID	FLUORESCENT
		MODEL NO.	MODEL NO.	MODEL NO.
12.0	10.0	WS1210INC	WS1210MH	WS1210CF
14.0	10.0	WS1410INC	WS1410MH	WS1410CF
16.0	11.0	WS1611INC	WS1611MH	WS1611CF
18.0	12.0	WS1812INC	WS1812MH	WS1812CF

Dimensions do not include mounting hardware.



RW2009INC-FINISHED BRONZE



WS1812CF-FINISHED WHITE



AS1012CF-FINISHED WHITE



RW2007CF-FINISHED BLACK

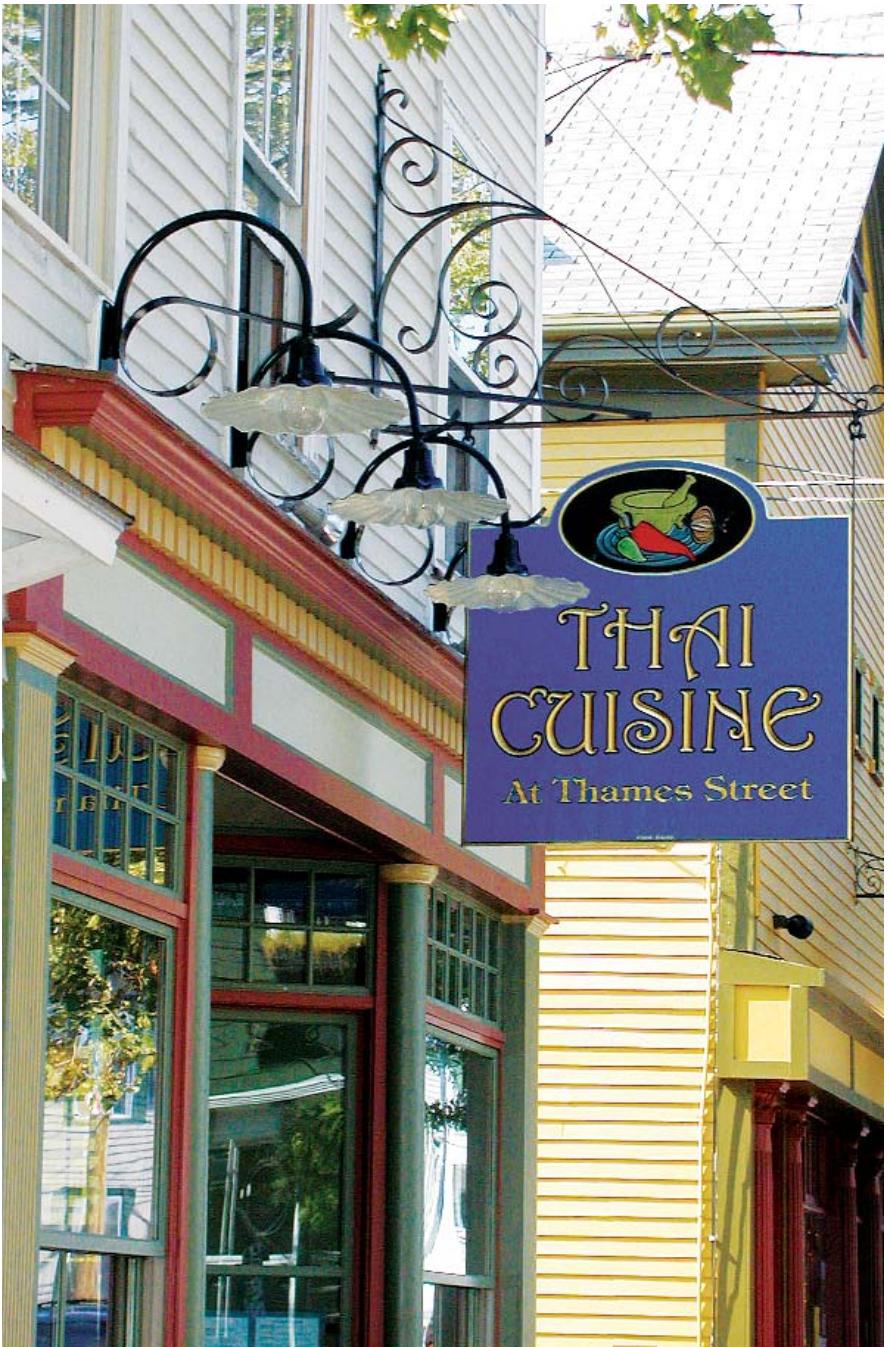

## RLM CLASSIC PROFILES

### RLM Lighting fixtures...made by SPECTRUM

SPECTRUM Lighting presents a collection of RLM "Classics", modern interpretations of time-proven designs.

Fixtures are available in compact fluorescent, metal halide and incandescent lamping, with a variety of mounting systems to suit every application.

Reflectors are made of heavy gauge aluminum, brass, copper, galvanized steel and cast aluminum.

Reflector exteriors are finished to exact specifications in powder coat, or epoxy paint with

white interiors for superior light output. Natural metal finish fixtures have matching interiors.

Spinning, fabrication, painting and assembly are done by SPECTRUM in our Massachusetts factory, using top quality components, to assure years of problem-free use. Special metal, and custom finishes, as well as custom shapes and mounting arms are available for unusual applications.

Just give us a call.



RLM-073

# CAFE SERIES

## Very Visible SMALL PROFILES...

The Spectrum Lighting "Cafe" Series is a collection of small profile pendants. The shades hang easily and are perfectly proportioned for small spaces. Fixtures may be placed individually or massed to create a decorative element. "Cafe" Series fixtures are available as compact fluorescent or incandescent, for indoor use.



SD1206CF-FINISHED RED

Dimensions do not include mounting hardware.

 <p>RED BARON FINISH</p>	<b>ANGLED CONTEMPORARY</b>		<b>INCANDESCENT</b>	<b>FLUORESCENT</b>
	DIA	HT	MODEL NO. AC1007INC	MODEL NO. AC1007CF
 <p>PLATINUM FINISH</p>	<b>BULLET 40</b>		<b>INCANDESCENT</b>	<b>FLUORESCENT</b>
	DIA	HT	MODEL NO. BU40INC	MODEL NO. BU40CF
 <p>GLOSS BLACK FINISH</p>	<b>EURO BULLET 60</b>		<b>INCANDESCENT</b>	<b>FLUORESCENT</b>
	DIA	HT	MODEL NO. EB60INC	MODEL NO. EB60CF
 <p>POLISHED BRASS</p>	<b>LAVA CONE 50</b>		<b>INCANDESCENT</b>	<b>FLUORESCENT</b>
	DIA	HT	MODEL NO. LC50INC	MODEL NO. LC50CF
 <p>BRUSHED ALUMINUM</p>	<b>RAYED BULLET 70</b>		<b>INCANDESCENT</b>	<b>FLUORESCENT</b>
	DIA	HT	MODEL NO. RB70INC	MODEL NO. RB70CF
 <p>PLATED CHROME</p>	<b>STEP DOME</b>		<b>INCANDESCENT</b>	<b>FLUORESCENT</b>
	DIA	HT	MODEL NO. SD1206INC	MODEL NO. SD1206CF
 <p>VERDE GREEN FINISH</p>	<b>WIDE PENDANT</b>		<b>INCANDESCENT</b>	<b>FLUORESCENT</b>
	DIA	HT	MODEL NO. WP1906INC	MODEL NO. WP1906CF



# PIER LIGHT SERIES

SPECTRUM Lighting's PIER LIGHT series echos the latest European styling with a classic flair. All PIER LIGHT Series fixtures look best with a glass jar. Please specify when ordering.

		INCANDESCENT	HID	FLUORESCENT
DIA	HT	MODEL NO.	MODEL NO.	MODEL NO.
14.0	11.0	PL1411INC	PL1411MH	PL1411CF
16.0	13.0	PL1613INC	PL1613MH	PL1613CF
20.0	15.0	PL2015INC	PL2015MH	PL2015CF

## PIER LIGHT

Attractive exterior design has wide distribution from angled shade and through open "tiered" rings. Wall, pole or pendant mounted.



		INCANDESCENT	HID	FLUORESCENT
DIA	HT	MODEL NO.	MODEL NO.	MODEL NO.
14.0	08.0	PS1408INC	PS1408MH	PS1408CF
16.0	09.0	PS1609INC	PS1609MH	PS1609CF
20.0	11.0	PS2011INC	PS2011MH	PS2011CF

## PIER LIGHT-SHORT

A pier light, with a lower profile, and downlight only distribution. Wall, pole or pendant mounted.



## CONCORDIA

Curved shade and lower rings modify downlight provide enhanced light spread and allow lower mounting height.

		INCANDESCENT	HID	FLUORESCENT
DIA	HT	MODEL NO.	MODEL NO.	MODEL NO.
18.0	12.0	CN1812INC	CN1812MH	CN1812CF



## PIER LIGHT STRAIGHT

Straight mounting arm, connects to side of fixture allowing straight 90° mounting from structure.

		INCANDESCENT	HID	FLUORESCENT
DIA	HT	MODEL NO.	MODEL NO.	MODEL NO.
14.2	11.2	PN1411INC	PN1411MH	PN1411CF
16.0	13.2	PN1613INC	PN1613MH	PN1613CF
20.0	15.2	PN2015INC	PN2015MH	PN2015CF



## EXPANDED DOME

Large dome allows ballast to be mounted directly in fixture, simplifying installation and maintenance.



		INCANDESCENT	HID	FLUORESCENT
DIA	HT	MODEL NO.	MODEL NO.	MODEL NO.
20.0	15.0	ED2015INC	ED2015MH	ED2015CF



SS1610CF-POLISHED NICKEL

## SCHOOLHOUSE FIXTURES

DIA	HT	INCANDESCENT MODEL NO.	HID MODEL NO.	FLUORESCENT MODEL NO.
14.0	8.0	SS1408INC	SS1408MH	SS1408CF
16.0	10.0	SS1610INC	SS1610MH	SS1610CF

POLISHED  
NICKEL

Fitting for the top of the schoolhouse globes allows mounting from stem, or wall mounted stem (see page 12). Oval link chain mounting also available. **(CHN-\*)** \*specify length.



## INDOOR/OUTDOOR UTILITY LIGHTS

Outdoor wet location fixtures, with cast housings and frosted glass lenses. Housings are die-cast aluminum.

### DOCK LIGHT

Multi-pattern amplifying lens, protected by cast wire guard. front re-lamping. Cast housing.

9" DIA.  
16" DIA.

INCANDESCENT  
MODEL NO.  
DO09INC  
DO16INC

FLUORESCENT  
MODEL NO.  
DO09CF  
DO16CF

### SHADED DOCK LIGHT

Solid upper shade prevents glare and light pollution, directing light downward. Cast housing.

9" DIA.  
16" DIA.

INCANDESCENT  
MODEL NO.  
DS09INC  
DS16INC

FLUORESCENT  
MODEL NO.  
DS09CF  
DS16CF

### OVAL DOCK LIGHT

Oblong shape allows mounting on narrow piling. Front re-lamping, cast guard and housing.

9" HT.

INCANDESCENT  
MODEL NO.  
DV06INC

FLUORESCENT  
MODEL NO.  
DV06CF

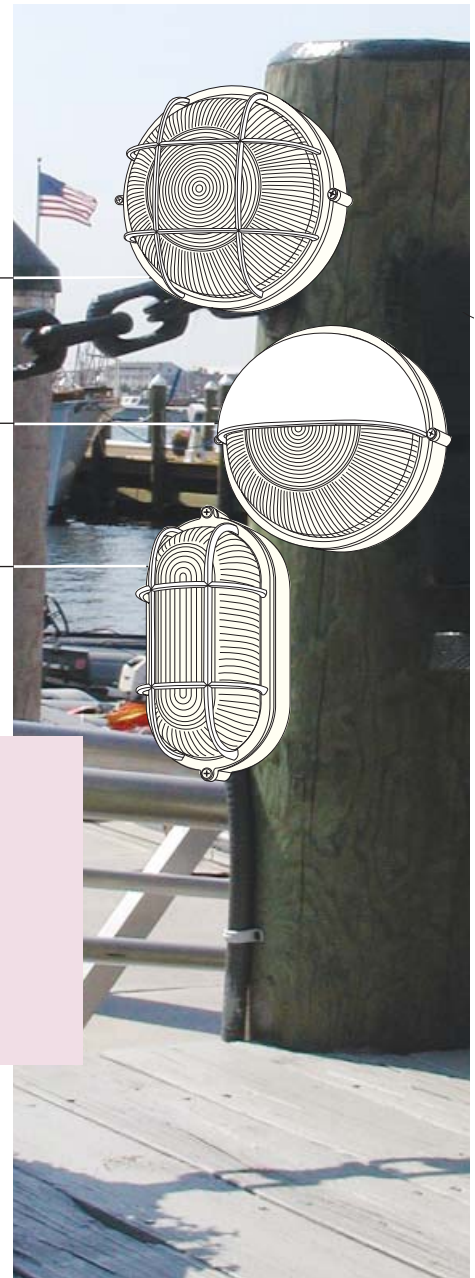

## DECO "INDUSTRIAL LOOK" VAPOR-TIGHT FIXTURES

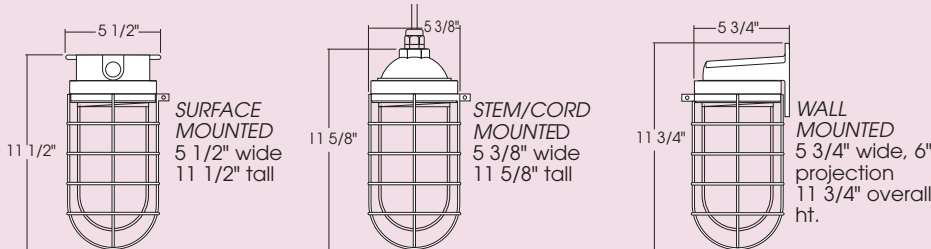

Durable Outdoor Fixtures-glass protective enclosures, cast tops with optional wire guards. Available in three mounting choices. Wet Location listed. Finish must be specified.

INCANDESCENT  
MODEL NO.  
SURFACE MOUNTED  
GJ2SMINC  
STEM/CABLE MOUNTED  
GJ2PMINC  
WALL MOUNTED  
GJ2WMINC

HID  
MODEL NO.  
SURFACE MOUNTED  
GJ2SMMH  
STEM/CABLE MOUNTED  
GJ2PMMH  
WALL MOUNTED  
GJ2WMMH

FLUORESCENT  
MODEL NO.  
SURFACE MOUNTED  
GJ2SMCF  
STEM/CABLE MOUNTED  
GJ2PMCF  
WALL MOUNTED  
GJ2WMCF

# SIGN LIGHTING

		INCANDESCENT	HID	FLUORESCENT
DIA	HT	MODEL NO.	MODEL NO.	MODEL NO.
8.0	8.0	AR0808NC	AR0808MH	AR0808CF
10.0	12.0	AR1012NC	AR1012MH	AR1012CF
12.0	14.0	AR1214NC	AR1214MH	AR1214CF

Note: 4" enclosure jar extends well beyond 8" and 10" shade profiles.

## ANGLED REFLECTOR

Wide spread angled reflector bowl (30°) for light directed toward wall or signage, while shielding light source.



## ANGLED SIGN

Angled reflector bowl (30°) directs light with no glare in surrounding areas.



		INCANDESCENT	HID	FLUORESCENT
DIA	HT	MODEL NO.	MODEL NO.	MODEL NO.
7.0	9.0	AS0709INC	AS0709MH	AS0709CF
9.0	10.0	AS0910INC	AS0910MH	AS0910CF
12.0	14.0	AS1214INC	AS1214MH	AS1214CF

Note: 4" enclosure jar will not fit 7" shade profile, and extends beyond 9" profile.

## SIGN LIGHT

Machined aluminum sign light, 2" focus adjustment. 50 watt MR16 max, with electronic transformer.



USING SPECTRUM RLM SIGN LIGHTING... Distance between fixtures affects brightness on sign or building. Photometrics at right and below show wall washing and sign illumination. Angled Sign and Angled Reflector profiles are usually mounted about 2' to 4' from walls or signs and 4' to 10' apart. The Sign light, a machined aluminum cylinder, features an adjustable focus socket for flood or spot lighting from a single source, shown in the flood lighting mode at right, on 3' centers.

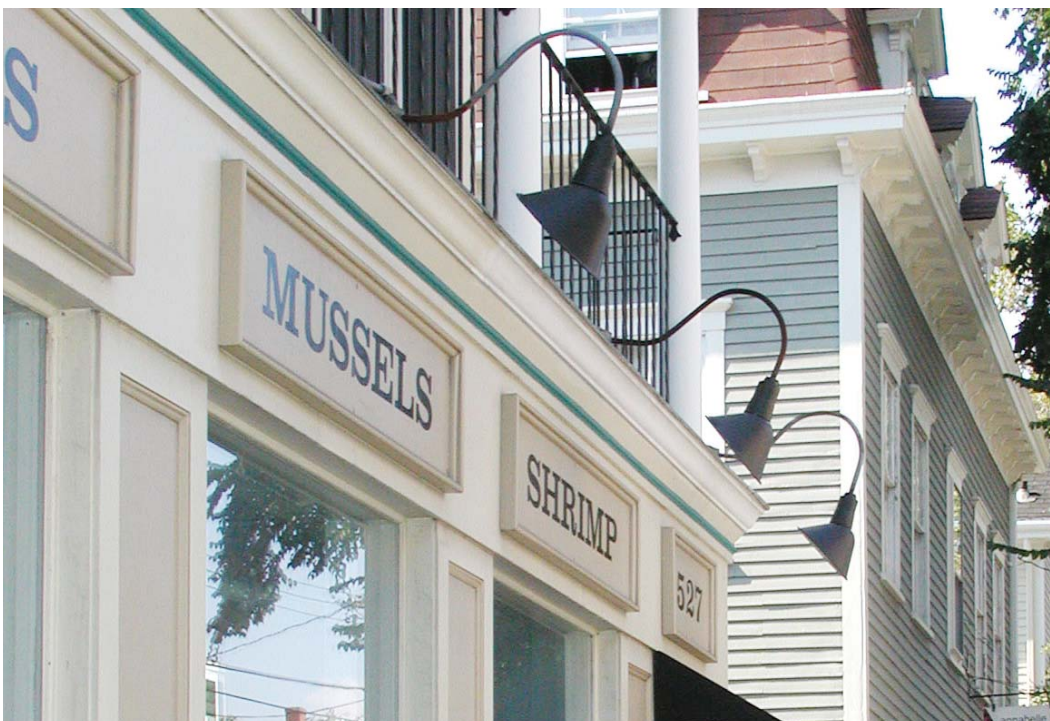
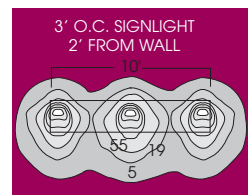
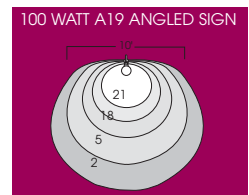
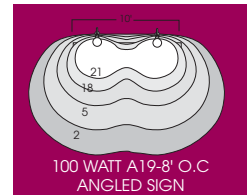
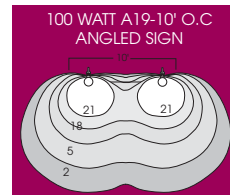

AS1012CF-FINISHED CHARCOAL

## ENCLOSURES

Factory installed. Specify when ordering.

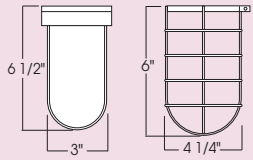

**FJ1-** 3" Frosted Glass Jar  
(75W / 32W max)

**GJ1-** 3" Glass Jar  
(100 W max)

**LJ1-** 3" Lexan Jar  
(75 W max)

**CG1-** Cast Wire Guard

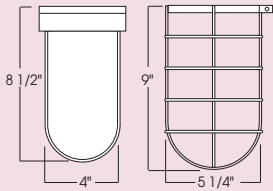

**FJ2-** 4" Frosted Glass Jar  
(100 W / 42W max)

**GJ2-** 4" Glass Jar  
(150W IN/100 MH/  
42W max)

**LJ2-** 4" Lexan Jar  
(42W max)

**WJ2-** Wire Guard

Colored jars are available-Please call the factory

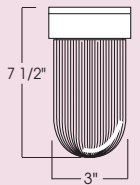

**PJ3-** 3" Prismatic  
Glass Jar  
(100W IN/  
32W max)

**GL6-** 6" Opal Glass Globe  
(100WIN / 42W max)

**PL6-** 6" Lexan Glass Globe  
(26 WQPL max)

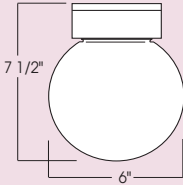

## GUARDS

Practical and durable formed chrome wire guards for protection or style.

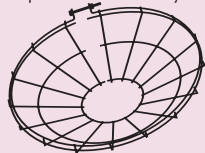

**WG12** 12" dia wire guard

**WG14** 14" dia wire guard

**WG16** 16" dia wire guard

**WG18** 18" dia wire guard



**CG\***-Clear Glass-with  
safety chain & clips. Not  
for all profiles. Frosted glass  
available

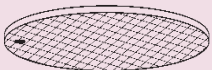

**PG\***-Prismatic Glass-with  
safety chain & clips. Not  
for all profiles.  
\* Diameter

## MOUNTING ACCESSORIES

Spectrum Lighting makes it simple to choose the perfect mounting. A cast pipe support fitting (**CP-6**) fits onto fluorescent and HID ballast housings or directly to the wall, with decorative covers for a finished look.

### Compact Fluorescent Mounting

**Cast ballast housing CP-10**  
for use with **CP-6**  
for wall mounting

**Spun ballast housings: CP-13**  
ceiling mount for  
electronic ballasts.

**CP-15** housing  
for larger dimming and  
emergency ballasts

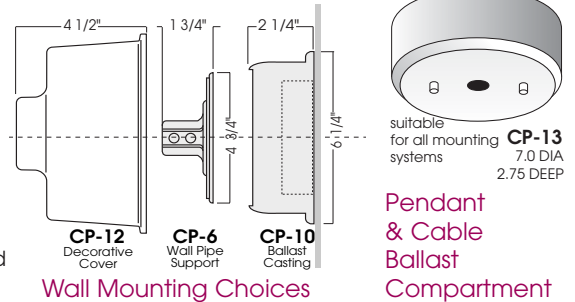

### HID Mounting

Choose cast ballast housing or spun aluminum round housing (for surface mounted ballasts) with mounting accessories - or choose the remote F-can ballast installation.

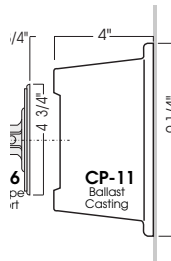
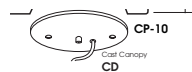

**WALL MOUNTING  
CAST BALLAST BOXES**  
(with plate and gasket)

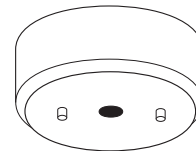

**Ballast Housing  
CP-13**  
7.0 DIA  
2.75 DEEP  
**CEILING MOUNTED  
SPUN BALLAST BOX**  
(with plate and gasket)  
100 Watt Maximum

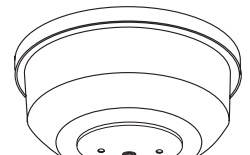

**CP-15**  
10" Dia  
5" Deep  
SHOWN WITH  
CAST  
CANOPY  
**CEILING MOUNTED  
DECO ROUND BALLAST BOX**  
(heavy gauge spun aluminum)  
250 Watt Maximum

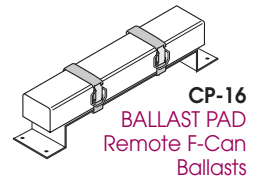

**CP-16**  
**BALLAST PAD**  
Remote F-Can  
Ballasts

### INCANDESCENT mounting

**CP-6** with optional  
spun aluminum  
decorative  
wall canopy (**CP-3**).

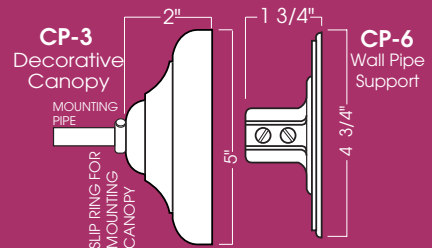

## Pendant and Cable Mounting for Classic RLM Fixtures

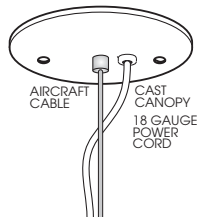

**CD-** Cast Canopy,  
Aircraft Cable  
and Straight Cord  
(6' std.)  
**CD-CC-** Coil Cord

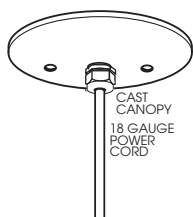

**CM-** Cast Canopy,  
Cord (white or  
black),  
Adjustable strain  
relief. (6' std.)

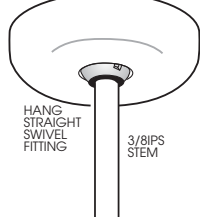

**HM-** Hang-Straight  
Stem / Canopy  
Assembly.  
(3' std.) 3/8 IP

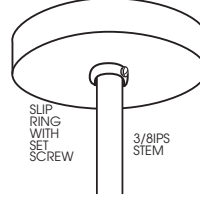

**PM-** Rigid Stem /  
Canopy  
Assembly.  
(3' std.) 3/8 IP

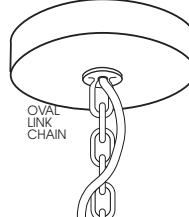

**CHN-** Chain/  
Canopy  
Assembly.  
(3' std.)  
18 ga.cord

A selection of pendant and cable mounting systems to suit any installation. Cast canopies (CD, CM) may be installed directly to ballast box casting (CP-10) or mounted directly to J box. Note: Stem is available in optional 1/4 IP, 1/2 IP

# Wall mounting Standards

SPECTRUM Lighting provides the mounting systems shown here for the safe installation of their RLM fixtures. Curved and cantilevered mounting standards are used for power feed as well as decorative elements. (Note: Most HID and fluorescent fixtures have remote ballasts.)

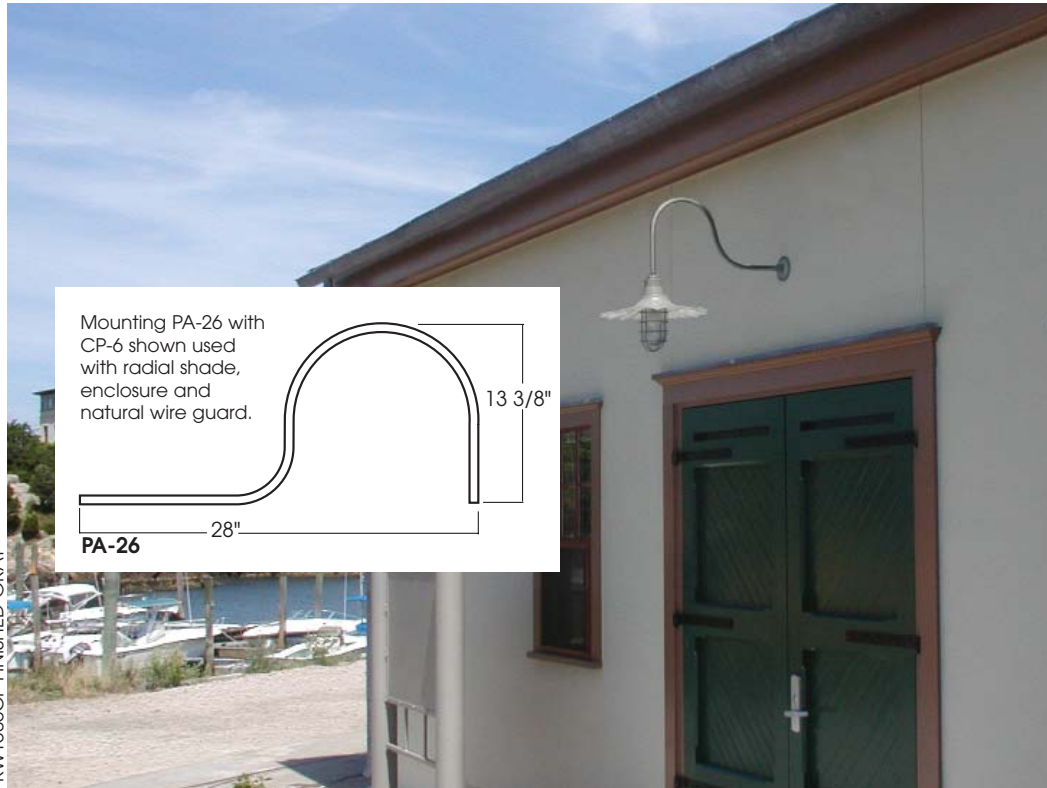
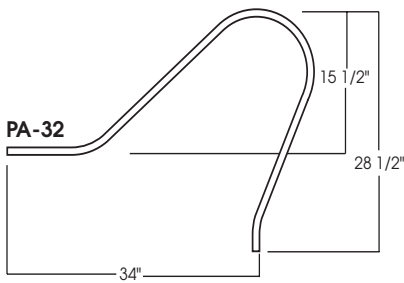
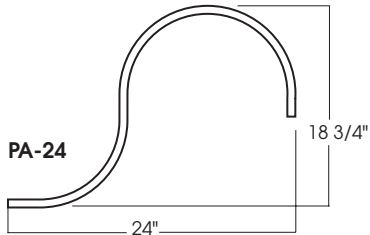
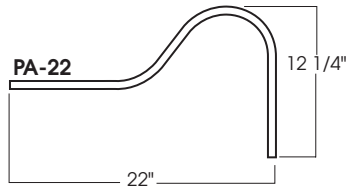
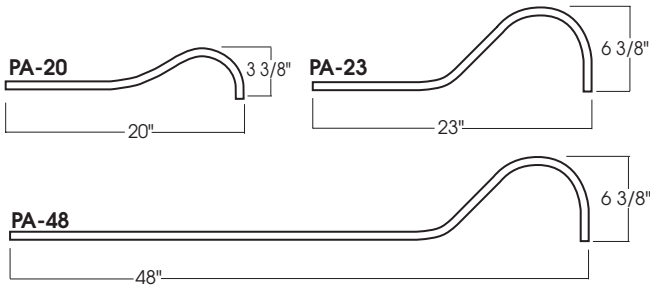

RW1606CF-FINISHED GRAY

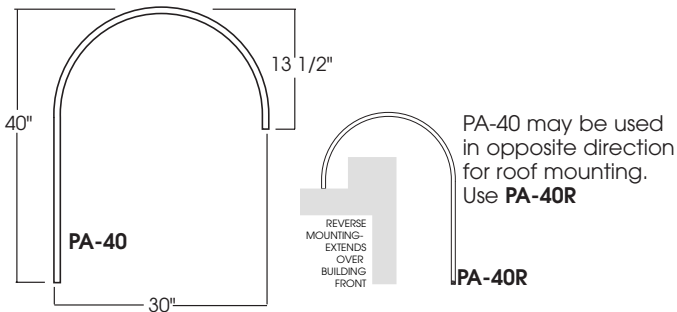
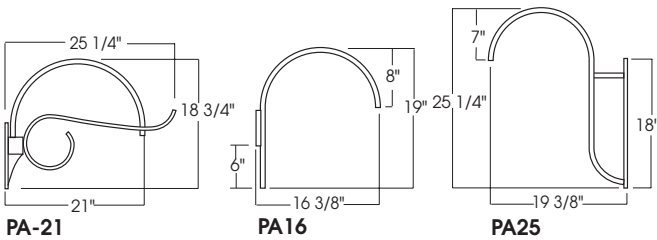

SPECTRUM Lighting uses 1/2 IP for most pipe mounting configurations. 3/4 IP is available and will be used if fixture weight demands heavier support for safe installation.

**Heavy 2" Pipe for Special Use**

The mounting systems shown here for outdoor use, wall or pole mounted, are constructed of 2" pipe for strength and durability. Note: cast HID ballast box may be used with other wall pipe mounting assemblies-consult the factory. Tenon fittings available, consult the factory.

PA238-PF3"  
 PA238-PF4"  
 PA238-WM2  
 PA238-WMIBL

# How to order Compact Fluorescent Classic RLM fixtures.

1. Select **RLM Profile Shape** model no. Be certain model no ends in CF for Compact Fluorescent Fixture.
2. Specify lamp type, Wattage and voltage Do not exceed wattage for housing or enclosure
3. Specify Color
5. Choose lamp enclosure (if required or desired). Note: enclosures for lamps must be specified at time of order. *Adaptors are factory-installed and may not be installed in the field.*
6. Choose Mounting (specify stem length if other than 36" for pendant mounting)
7. Specify Ballast Mounting system.
8. Select any options desired. Specify color or finish if needed.

## TYPICAL WALL MOUNT

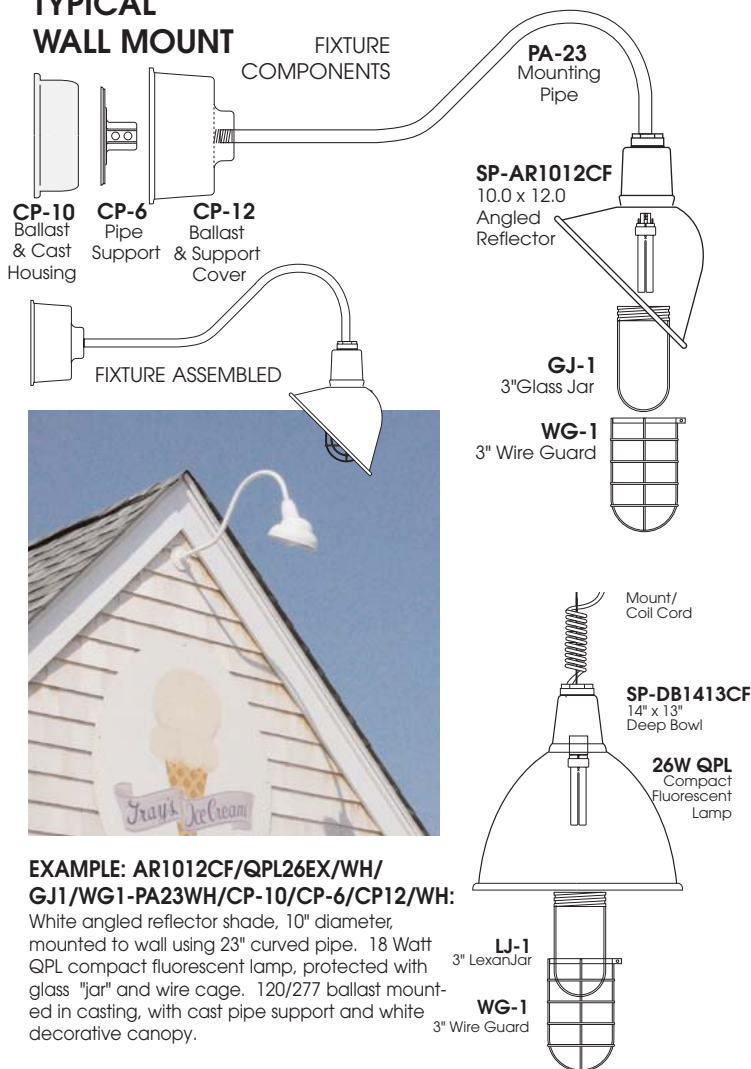

## TYPICAL CEILING MOUNT

FLUORESCENT		LAMPING	
MODEL NO.	MAX WATTS	LAMP TYPE	LAMP WATTS
AC1007CF	42W	QPL Quad Fluorescent 13,18,26 Watt	18
AR0809CF	42W		26*
AR1012CF	42W		32
AS0709CF	42W	PLT Triple Tube Fluorescent 26,32,42 Watt	42
AS0910CF	42W		Not to exceed rated wattage of shade or enclosure
AS1214CF	42W		
BU40CF	42W		
CN1812CF ††	42W		
DB1009CF	42W		
DB1211CF	42W		
DB1413CF	42W		
DB1615CF	42W		
DB1817CF	42W		
EB60CF	42W		
ED2015CF	42W		
EP1414CF	42W		
LC50CF	42W		
OR1818CF	42W		
PL1411CF †	42W		
PL1613CF †	42W		
PL2015CF †	42W		
PN1114CF ††	42W		
PN1613CF ††	42W		
PN2015CF ††	42W		
PS1408CF †	42W		
PS1609CF †	42W		
PS2011CF †	42W		
RW1405CF	42W		
RW1606CF	42W		
RW2007CF	42W		
RB70CF	42W		
SD1206CF	42W		
WP1906CF	42W		
WS1210CF	42W		
WS1410CF	42W		
WS1611CF	42W		
WS1812CF	42W		
SS1408CF	42W		
SS1610CF	42W		
DO09CF	42W		
DO16CF	3X42W		
DS09CF	42W		
DS16CF	3X42W		
DV06CF	42W		
GJ2SMCF	42W		
GJ2PMCF	42W		
GJ2WMCF	42W		

\*specify QPL or PLT

† Uses FJ-2 or GJ-2-Specify when ordering.  
 †† Wall mount as shown only. Uses FJ-2 or GJ-2 Enclosures. No wire guard.

BALLAST	SHADE COLOR	LAMP ENCLOSURE	MOUNTING		BALLAST ENCLOSURE	OPTIONS
			PIPE MOUNTING	PENDANT MOUNTING		
<p><b>EX-</b> Electronic dual voltage 120/277 Remote</p> <p>Choose Casting <b>CP-10</b> or use with extended dome profile ED2015CF</p> <p>Consult factory for other voltages</p>	<p><b>Standard finishes</b></p> <p><b>GW-</b> Gloss White <b>TW-</b> Texture White <b>BT-</b> Texture Black <b>GB-</b> Oil Black <b>MB-</b> Matte Black <b>MT-</b> Texture silver <b>SI-</b> Silver <b>CO-</b> Copper Metallic <b>AY-</b> Aero Yellow <b>OR-</b> Orange <b>RD-</b> Red Baron <b>EG-</b> Evergreen <b>AG-</b> Pub Green <b>VE-</b> Verde Green <b>BL-</b> Blue Streak <b>AD-</b> Almond <b>CB-</b> Camel <b>BR-</b> Brecchia <b>SN-</b> Sungold <b>BZ-</b> Statuary Bronze (white interior)</p> <p><b>Natural Metals</b></p> <p><b>BA-</b> Brushed Aluminum <b>BC-</b> Brushed Copper <b>BR-</b> Polished Brass <b>BRB-</b> Brushed Brass (matching interiors)</p> <p><b>Plated finishes</b></p> <p><b>CR-</b> Chrome <b>GA-</b> Galvanized <b>PN-</b> Polished Nickel <b>PB-</b> Polished Plated Brass (matching interiors)</p> <p>Note: Special finishes require longer lead time.</p>	<p><b>NOTE:</b> Lamp enclosures may not fit all fixtures- please consult factory</p> <p><b>FJ1</b> 3" Frosted Glass Jar-32 W max 26 W. PLT only</p> <p><b>GJ1</b> 3" Glass Jar 32 W max 26 W. PLT only</p> <p><b>LJ1</b> 3" Lexan Jar 32 W max 26 W. PLT only</p> <p><b>PJ3</b> 3" Prismatic Lexan Jar 32 W max</p> <p><b>CJ1</b> Cast Guard fits 3" Jar natural metal finish-standard</p> <p><b>FJ2</b> 4" Frosted Glass Jar-42 W max</p> <p><b>GJ2</b> 4" Glass Jar 42 W max</p> <p><b>LJ2</b> 4" Lexan Jar 42 W max</p> <p><b>WJ2</b> Wire Guard fits 4" Jar natural metal finish-standard</p> <p><b>GL6</b> 6" Opal Glass Globe 42W max</p> <p><b>PL6</b> 6" Lexan Globe 32 W max</p> <p>Note: Enclosures must be specified at time of order</p>	<p><b>PA-20</b> <b>PA-22</b> <b>PA-23</b> <b>PA-24</b> <b>PA-26</b> <b>PA-32</b> <b>PA-40</b> <b>PA-40R</b> (for roof mounting) <b>PA-48</b> <b>PA-90*</b> <i>Use above with (CP-6) Mounted to ballast box or directly to wall</i></p> <p><u>Mounting with Wall plate</u> <b>PA-16</b> <b>PA-21</b> <b>PA-25</b></p> <p><u>2" Dia Pipe Mounting</u> <b>PA-238WM2</b> <b>PA-238WMIBL</b></p> <p>Post top Mounting <b>PA-238PF3</b> 3" Post top fitter <b>PA-238PF4</b> 4" Post top fitter</p> <p>* Specify length</p> <p>Specify finish of mounting pipes, if other than fixture</p>	<p><b>CD(*)</b> Cord and Cable 36" standard</p> <p><b>CM(*)</b> Cord and Strain Relief 36" standard</p> <p><b>HM(*)</b> Hang Straight 3/8 IP Pendant 36" standard</p> <p><b>HMAT(*)</b> Hang Straight 3/8 IP Pendant All-Thread field adjustable 36" standard</p> <p><b>PM(*)</b> 3/8 IP Pendant Slip Ring 36" standard</p> <p><b>CHN(*)</b> Chain &amp; Cord 36" standard Canopy and stem finished to match fixture</p> <p>*length must be specified</p> <p>cord : <b>WH-</b> White or <b>BL-</b> Black</p>	<p><b>CP-10</b> Indoor electronic ballast and wiring compartment in casting mount on wall, ceiling, or above ceiling</p> <p><b>CP-13</b> Indoor electronic ballast and wiring compartment Spun Aluminum 2 3/4" deep</p> <p><b>CP-18</b> Decorative deep indoor electronic ballast and wiring compartment</p>	<p><b>CP-6</b> Casting for wall/pipe mounting interface</p> <p><b>CP-12</b> Deep Decorative Canopy fits over CP-6 &amp; CP-10</p> <p><b>WG12</b> 12" Wire Guard <b>WG14</b> 14" Wire Guard <b>WG16</b> 16" Wire Guard <b>WG18</b> 18" Wire Guard</p> <p><b>CG12-*</b> Clear Glass safety chain and clips <b>PG14-*</b> Prismatic Glass safety chain and clips</p> <p>* Specify diameter</p>

Dimensions shown are nominal. Spectrum Lighting is continually improving products and reserves the right to make changes that will not alter performance or appearance.

# How to order HID Classic RLM fixtures

1. Select **RLM Profile Shape** model no. Be certain model no. ends in MH for HID Fixture.
2. Specify lamp type, Wattage and Ballast type and Voltage. Do not exceed wattage for housing or enclosure
3. Specify Color
4. Choose lamp enclosure (if required or desired). Note: enclosures for lamps must be specified at time of order. *Adaptors are factory-installed and may not be field-installed.*
5. Choose Mounting , specify finish. (specify suspension length cable for pendant or cable mounting)
6. Specify Ballast Mounting system.
7. Select any options desired. Specify color or finish if appropriate.

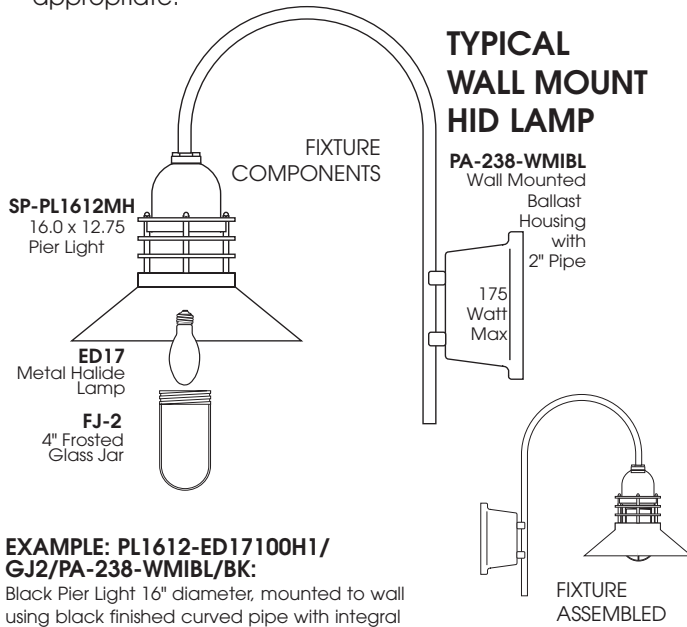

**EXAMPLE: PL1612-ED17100H1/ GJ2/PA-238-WMIBL/BK:**

Black Pier Light 16" diameter, mounted to wall using black finished curved pipe with integral casting (finished black) for 120 Volt high power factor ballast. 100 watt ED17 lamp protected with 4" glass "jar".

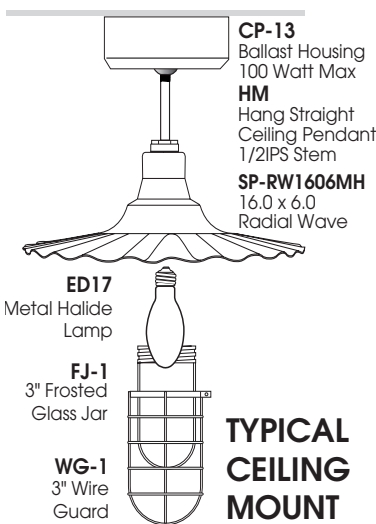

HID MODEL NO.	OPEN RATED MAX WATTS	LAMPING	
		LAMP TYPE	LAMP WATTS
AR0809MH	100W	<b>MH</b> Metal Halide requires enclosure	<b>35/39</b>
AR1012MH	100W		<b>50</b>
AR1214MH	175W		<b>70</b>
AS0709MH	100W		<b>100</b>
AS0910MH	150W		<b>175</b>
AS1214MH	175W	<b>MHMP</b> Metal Halide open rated	<b>250</b>
CN1812MH†	175W		<b>400</b>
DB1009MH	100W		Not to exceed rated wattage of shade or enclosure
DB1211MH	100W		
DB1413MH	250W		
DB1615MH	250W	<b>HPS</b> High Pressure Sodium	
DB1817MH	400W		
ED2015MH	250W		
EP1414MH	150W		
OR1818MH	175W		
PL1411MH †	175W		
PL1612MH †	175W		
PL2015MH †	175W		
PN1114MH ††	175W		
PN1612MH ††	175W		
PN2015MH ††	175W		
PS1408MH †	175W		
PS1609MH †	175W		
PS2011MH †	175W		
RW1405MH	100W		
RW1606MH	150W		
RW2007MH	175W		
WP1906MH	150W		
WS1210MH	100W		
WS1410MH	250W		
WS1611MH	400W		
WS1812MH	400W		
SS1408MH	150W		
SS1610MH	150W		
GJ2SMMH	175W		
GJ2PMMH	175W		
GJ2WMMH	175W		

† Uses FJ-2 or GJ-2-Specify when ordering.  
 †† Wall mount as shown only. Uses FJ-2 or GJ-2 Enclosures. No wire guard.

BALLAST	VOLTS	SHADE COLOR	LAMP ENCLOSURE	MOUNTING		BALLAST ENCLOSURE	OPTIONS
				PIPE MOUNTING	PENDANT MOUNTING		
<p>Note: HID Ballasts are mounted remote,</p> <ul style="list-style-type: none"> <li>expanded dome shade may hold ballast <b>(ED)</b></li> </ul> <p><b>H-</b> High Power Factor Magnetic F-Can</p> <p><b>EX-</b> Electronic Ballast 120/277</p> <p><b>CC-</b> Core &amp; Coil* * Must be enclosed. Choose</p> <p><b>C-11</b> Casting or</p> <p><b>C-15</b> Spun Aluminum circular housing</p> <p>or use with extended dome profile ED2015MH</p>	<p>1-120 2-277 Consult factory for other voltages</p>	<p><b>Standard finishes</b></p> <p><b>GW-</b> Gloss White</p> <p><b>TW-</b> Texture White</p> <p><b>BT-</b> Texture Black</p> <p><b>GB-</b> Oil Black</p> <p><b>MB-</b> Matte Black</p> <p><b>MT-</b> Texture Silver</p> <p><b>SI-</b> Silver</p> <p><b>CO-</b> Copper Metallic</p> <p><b>AY-</b> Aero Yellow</p> <p><b>OR-</b> Orange</p> <p><b>RD-</b> Red Baron</p> <p><b>EG-</b> Evergreen</p> <p><b>AG-</b> Pub Green</p> <p><b>VE-</b> Verde Green</p> <p><b>BL-</b> Blue Streak</p> <p><b>AD-</b> Almond</p> <p><b>CB-</b> Camel</p> <p><b>BR-</b> Brecchia</p> <p><b>SN-</b> Sungold</p> <p><b>BZ-</b> Statuary Bronze (white interior)</p> <p><b>Natural Metals</b></p> <p><b>BA-</b> Brushed Aluminum</p> <p><b>BC-</b> Brushed Copper</p> <p><b>BR-</b> Polished Brass</p> <p><b>BRB-</b> Brushed Brass (matching interiors)</p> <p><b>Plated finishes</b></p> <p><b>CR-</b> Chrome</p> <p><b>GA-</b> Galvanized</p> <p><b>PN-</b> Polished Nickel</p> <p><b>PB-</b> Polished Plated Brass (matching interiors)</p> <p>Note: Special finishes require longer lead time.</p>	<p><b>NOTE:</b> Lamp enclosures may not fit all fixtures-please consult factory</p> <p><b>FJ2</b> 4" Frosted Glass Jar 100 W max ED17 lamps only</p> <p><b>GJ2</b> 4" Glass Jar 100 W max ED17 lamps only</p> <p><b>WJ2</b> Wire Guard fits 4" Jar natural metal finish-standard</p> <p><b>GL6</b> 6" Opal Glass Globe 150 W max</p> <p>Note: Enclosures must be specified at time of order</p>	<p><b>PA-20</b> <b>PA-22</b> <b>PA-23</b> <b>PA-24</b> <b>PA-26</b> <b>PA-32</b> <b>PA-40</b> <b>PA-40R</b> (for roof mounting) <b>PA-48</b> <b>PA-90*</b> <i>Use above with <b>(CP-6)</b> Mounted to ballast box or directly to wall</i></p> <p><u>Mounting with Wall plate</u> <b>PA-16</b> <b>PA-21</b> <b>PA-25</b></p> <p><u>2" Dia Pipe Mounting</u> <b>PA-238WM2</b> <b>PA-238WMIBL</b></p> <p>Post top Mounting <b>PA-238PF3</b> 3" Post top fitter <b>PA-238PF4</b> 4" Post top fitter</p> <p>* Specify length</p> <p>Specify finish of mounting pipes, if other than fixture</p>	<p><b>CD(*)</b> Cord and Cable 36" standard</p> <p><b>CM(*)</b> Cord and Strain Relief 36" standard</p> <p><b>HM(*)</b> Hang Straight 3/8 IP Pendant 36" standard</p> <p><b>HMAT(*)</b> Hang Straight 3/8 IP Pendant All-Thread field adjustable 36" standard</p> <p><b>PM(*)</b> 3/8 IP Pendant Slip Ring 36" standard</p> <p><b>CHN(*)</b> Chain &amp; Cord 36" standard</p> <p>Canopy and stem finished to match fixture</p> <p>*length must be specified</p>	<p><b>CP-16</b> Remote Ballast Mounting Plate</p> <p><b>CP-11</b> Cast Ballast enclosure with gasket, mounting plate. Wall Mount</p> <p><b>CP-13</b> Indoor electronic ballast and wiring compartment Spun Aluminum 2 3/4" deep Ceiling Mount</p> <p><b>CP-15</b> Spun Aluminum Round Ballast Compartment Ceiling Mount</p> <p><b>CP-18</b> Decorative deep Indoor electronic ballast and wiring compartment</p> <p><b>CP-NEMA</b> Outdoor NEMA "Raintite" remote ballast compartment</p>	<p><b>CP-3</b> 7" Dia spun Canopy, slip ring fits over CF-6 wall mounting</p> <p><b>CP-6</b> Casting for wall/pipe mounting interface fits onto CP-11</p> <p><b>CP-16</b> remote ballast mounting plate</p> <p><b>SS-1</b> Schoolhouse Glass Shade Mounting Cap</p> <p><b>WG12</b> 12" Wire Guard</p> <p><b>WG14</b> 14" Wire Guard</p> <p><b>WG16</b> 16" Wire Guard</p> <p><b>WG18</b> 18" Wire Guard</p> <p><b>CG12-*</b> Clear Glass safety chain and clips</p> <p><b>PG14-*</b> Prismatic Glass safety chain and clips</p> <p>* Specify diameter</p>

Dimensions shown are nominal. Spectrum Lighting is continually improving products and reserves the right to make changes that will not alter performance or appearance.

# How to order **Incandescent** Classic RLM fixtures.

1. Select **RLM Profile Shape** model no. Be certain model no ends in INC for Incandescent Fixture.
2. Specify lamp type and wattage. Do not exceed wattage for housing or enclosure
3. Specify Color
4. Choose lamp enclosure (if required or desired). Note: enclosures for lamps must be specified at time of order. *Adaptors are factory-installed and may not be installed in the field.*
5. Choose Mounting System, and specify finish (specify stem or cord length for ceiling mounting)
6. Select any options desired. Specify color or finish if appropriate.

## TYPICAL WALL MOUNT

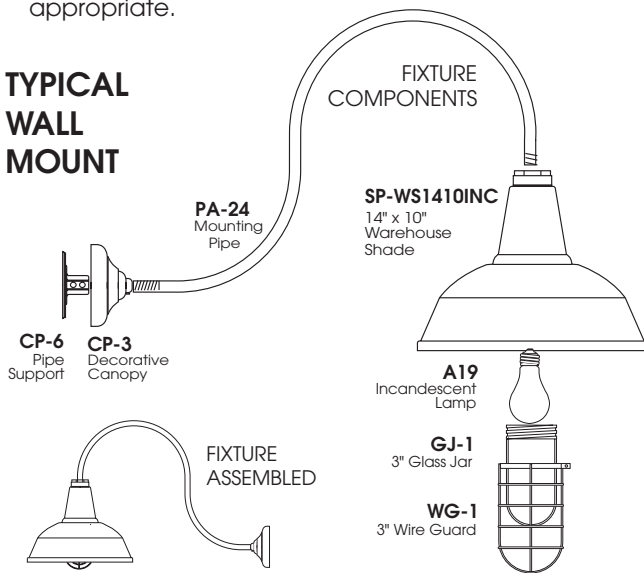

### EXAMPLE: WS1410INC-A19100/ GJ1/CG1/PA-24/CP-6/BK:

Black Warehouse shade, 14" diameter, mounted to wall using casting with double-curved pipe mounting. 100 watt A19 lamp protected with clear glass jar and wire cage.



## TYPICAL CEILING MOUNT

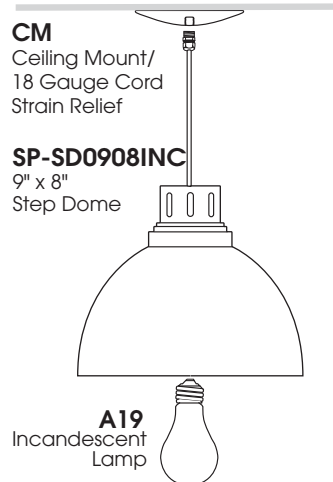

INCANDESCENT		LAMPING	
MODEL NO.	MAX WATTS	LAMP TYPE	LAMP WATTS
AC1007INC	150W	<b>A19</b>	<b>35</b>
AR0809INC	100W		
AR1012INC	150W		
AR1214INC	150W		
AS0709INC	100W		
AS0910INC	150W		
AS1214INC	150W		
BU40INC	200W		
CN1812INC †	200W		
DB1009INC	150W		
DB1211INC	150W		
DB1413INC	250W		
DB1615INC	300W		
DB1817INC	500W		
EB60INC	200W		
ED2015INC	300W		
EP1414INC	300W		
LC50INC	200W		
OR1818INC	300W		
PL1411INC †	200W		
PL1612INC †	200W		
PL2015INC †	200W		
PN1411INC ††	200W		
PN1612INC ††	200W		
PN2015INC ††	200W		
PS1408INC †	200W		
PS1609INC †	200W		
PS2011INC †	200W		
RW1405INC	100W		
RW1606INC	150W		
RW2007INC	300W		
RB70INC	200W		
SD1206INC	150W		
SL0305INCMR16	50W		
WP1906INC	150W		
WS1210INC	100W		
WS1410INC	150W		
WS1611INC	300W		
WS1812INC	500W		
SS1408INC	100W		
SS1610INC	150W		
DO09INC	100W		
DO16INC	300W		
DS09INC	100W		
DS16INC	300W		
DV06INC	60W		
GJ2SMINC	200W		
GJ2PMINC	200W		
GJ2WMINC	200W		

† Uses FJ-2 or GJ-2-Specify when ordering.  
 †† Wall mount as shown only. Uses FJ-2 or GJ-2 Enclosures. No wire guard.

VOLTAGE	SHADE COLOR	LAMP ENCLOSURE	MOUNTING		OPTIONS
			PIPE MOUNTING	PENDANT MOUNTING	
<p><b>120</b> Consult factory for other voltages</p>	<p><b>Standard finishes</b>  <b>GW-</b> Gloss White  <b>TW-</b> Texture White  <b>BT-</b> Texture Black  <b>GB-</b> Oil Black  <b>MB-</b> Matte Black  <b>MT-</b> Texture silver  <b>SI-</b> Silver  <b>CO-</b> Copper Metallic  <b>AY-</b> Aero Yellow  <b>OR-</b> Orange  <b>RD-</b> Red Baron  <b>EG-</b> Evergreen  <b>AG-</b> Pub Green  <b>VE-</b> Verde Green  <b>BL-</b> Blue Streak  <b>AD-</b> Almond  <b>CB-</b> Camel  <b>BR-</b> Brecchia  <b>SN-</b> Sungold  <b>BZ-</b> Statuary Bronze            (white interior)</p> <p><b>Natural Metals</b>  <b>BA-</b> Brushed Aluminum  <b>BC-</b> Brushed Copper  <b>BR-</b> Polished Brass  <b>BRB-</b> Brushed Brass (matching interiors)</p> <p><b>Plated finishes</b>  <b>CR-</b> Chrome  <b>GA-</b> Galvanized  <b>PN-</b> Polished Nickel  <b>PB-</b> Polished Plated Brass (matching</p>	<p><b>FJ1</b> 3" Frosted Glass Jar 100W max  <b>GJ1</b> 3" Glass Jar 100 W max  <b>LJ1</b> 3" Lexan Jar 100 W max  <b>PJ3</b> 3" Prismatic Lexan Jar 100 W max  <b>CJ1</b> Cast Guard fits 3" Jar natural metal finish-standard</p> <p><b>FJ2</b> 4" Frosted Glass Jar 200 W max  <b>GJ2</b> 4" Glass Jar 200W max  <b>WJ2</b> Wire Guard fits 4" Jar natural metal finish-standard</p> <p><b>GL6</b> 6" Opal Glass Globe 200W max</p> <p>Note: Enclosures must be specified at time of order</p>	<p><b>PA-20</b>  <b>PA-22</b>  <b>PA-23</b>  <b>PA-24</b>  <b>PA-26</b>  <b>PA-32</b>  <b>PA-40</b>  <b>PA-40R</b>            (for roof mounting)  <b>PA-48</b>  <b>PA-90*</b>  <i>Use above with (CP-6)            Mounted to ballast box            or directly to wall</i></p> <p><u>Mounting with Wall plate</u>  <b>PA-16</b>  <b>PA-21</b>  <b>PA-25</b></p> <p><u>2" Dia Pipe Mounting</u>  <b>PA-238WM2</b>  <b>PA-238WMIBL</b></p> <p>Post top Mounting  <b>PA-238PF3</b>            3" Post top fitter  <b>PA-238PF4</b>            4" Post top fitter</p> <p><i>* Specify length</i></p> <p>Specify finish of mounting pipes, if other than fixture</p>	<p><b>CD(*)</b> Cord and Cable 36" standard</p> <p><b>CM(*)</b> Cord and Strain Relief 36" standard</p> <p><b>HM(*)</b> Hang Straight 3/8 IP Pendant 36" standard  <b>HMAT(*)</b> Hang Straight 3/8 IP Pendant All-Thread field adjustable 36" standard</p> <p><b>PM(*)</b> 3/8 IP Pendant Slip Ring 36" standard</p> <p><b>CHN(*)</b> Chain &amp; Cord 36" standard</p> <p>Canopy and stem finished to match fixture</p> <p>*length must be specified</p> <p>cord :  <b>WH-</b> White or  <b>BL-</b> Black            specify</p>	<p><b>CP-6</b> Casting for wall/pipe mounting interface</p> <p><b>CP-3</b> Deep Decorative Canopy fits over CF-6</p> <p><b>SS-1</b> Schoolhouse Glass Shade Mounting Cap</p> <p><b>WG12</b> 12" Wire Guard  <b>WG14</b> 14" Wire Guard  <b>WG16</b> 16" Wire Guard  <b>WG18</b> 18" Wire Guard</p> <p><b>CG12-*</b> Clear Glass safety chain and clips  <b>PG14-*</b> Prismatic Glass safety chain and clips  <i>* Specify diameter</i></p>

Dimensions shown are nominal. Spectrum Lighting is continually improving products and reserves the right to make changes that will not alter performance or appearance.

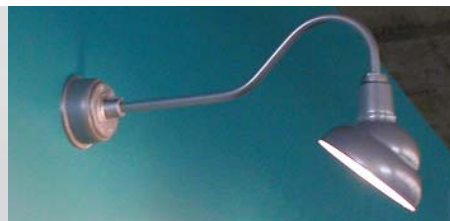

**SPECTRUM**  
LIGHTING, INC.

994 Jefferson Street . Fall River, MA 02721 . 508.678.2303 FAX 508.678.2260

[www.speclight.com](http://www.speclight.com)