



22" PRISMATIC TECH SERIES



PRX22LX

APPLICATION

22" Lumen Max LX series performance pendant for low, mid-bay and high-bay applications. Prismatic refractor provides horizontal and vertical distribution.

Decorative support arms and lower parts add visual appeal.

FEATURES

Extruded Fixture Housing (EXT) features a clean and modern design. Single-stage optical system for smooth light distribution. LED module and driver designed for ease of maintenance and replacement. Posi-lock refractor retention ring will absorb shocks and impacts. Optional safety cable. Variety of optical lenses and mounting methods.

FINISH

Multi-stage polyester powder-coat process applied on our dedicated paint lines. Variety of standard and custom finishes are available. All exposed materials are chromate pretreated to resist corrosion.

ELECTRONICS

LED system features high brightness white Nichia LEDs. 3-step MacAdam Ellipse binning. Standard CRI: 80+. Higher CRI, R9 and custom LED configurations are available; consult factory. Variety of electronic 120V/277V and dimming drivers. LED module is 2 circuit with 2 drivers for multicircuit option.

CONSTRUCTION

Extruded and machined 6063-T5 aluminum housing. Graphite gasket for optimal thermal management. Die-cast aluminum heat sink. Refractor made of cast UV stabilized acrylic. Arms are chrome plated, formed steel tubing. 1MR option is spun aluminum.

CODE COMPLIANCE

BAA compliant. ETL certified to meet US and Canadian standards. Suitable for dry or damp locations. Manufactured and tested to UL standards No. 1598/8750.

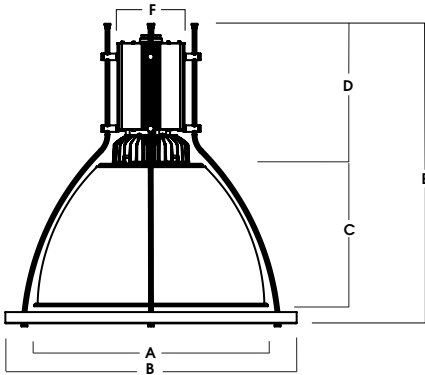

A	B	C	D	E	F
22.4 569.0 mm	28.0 711.2 mm	13.7 348.0 mm	12.3 312.4 mm	27.7 703.6 mm	6.5 165.5 mm

LUMENS / WATTAGE DATA				
PART NUMBER	SOURCE LUMENS ¹	DELIVERED LUMENS ²	SYSTEM WATTS	LPW
PRX22LX65L	6500	5675	54.1	105
PRX22LX100L	10000	8508	81.1	105
PRX22LX130L	13000	11193	103.9	86
PRX22LX140L	14000	12123	111.9	108

SERIES	LUMENS ¹	CCT	DRIVER / DIMMING ³	OPTIONS ⁴	MOUNTING ⁵	REFRACTOR	DIFFUSER OPTION	TIER OPTIONS	FINISH ⁹
PRX22LX	65L 6500 Lm	27K 2700K	EX Electronic Driver, 120V/277V DS10X 10%, 0-10V, 120V/277V DO10X 1%, 0-10V, 120V/277V DO103 1%, 0-10V, 347V	SAFETY OPTIONS FS Fusing 2CIR 2 Circuit SC1 Safety Cable SC2 Safety Cable Reflector to door	HM ⁶ Hang Straight AT ⁶ Hang Straight All Thread PM ⁶ Rigid Pendant Mount CD ⁶ Cord / Cable Mount HC ⁶ Hook & Cord NM2 ⁶ 1/2" NPT Hub NM3 ⁶ 3/8" NPT Hub EMCR 10W Canopy Mounted EM EMRM 7W Remote EM EMEN 7W Remote with Enclosure	DF22 22" Diffuse PR22 22" Clear OP22 22" Opal	TF3 6" Frosted Diffuser	TIER OPTIONS CFG Center Frosted Glass Tier FGR Frosted Glass Ring 1MR ⁷ Single Metal Ring	MW ¹⁰ Matte White MB ¹⁰ Matte Black PT ¹⁰ Platinum Silver CC Custom Color See Page 5 for Full Range of Color Options (83-90081)
	100L 10000 Lm	30K 3000K							
	130L 13000 Lm	35K 3500K							
	140L 14000 Lm	40K 4000K							

EXAMPLE: PRX22LX100L35KEX/HM36/PR22/CFG/PT

NOTES:

1 Nominal Source Lumens at 35K 2 Nominal Delivered Lumens at 35K with PR22-FGR 3 Contact Factory for Additional Options 4 See Product Options Page For Details 5 See Mounting Page for Details on Components and Finishes 6 Specify Length in Inches: See Mounting Page for Available Lengths 7 Mounting Supplied by Others 8 Same Finish as Housing 9 See Color Page for More Options / Consult Factory for Special Finishes 10 Standard Finishes



PROJECT: _____
TYPE: _____



Dimensions and values shown are nominal. Spectrum Lighting continually works to improve products and reserves the right to make changes which may alter the performance or appearance of products.

22" PRISMATIC

TECH SERIES / FIXTURE OPTIONS



STANDARD FINISHES

MW
MATTE WHITE



MB
MATTE BLACK



PT
PLATINUM SILVER



DECO-TIER OPTIONS

1MR
SINGLE METAL RING



CFG
CENTERED FROSTED GLASS

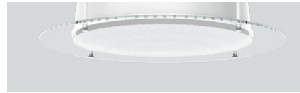

FGR
FROSTED GLASS RING



MOUNTING TYPES

HM / AT / PM
HANG STRAIGHT / ALL THREAD / PENDANT

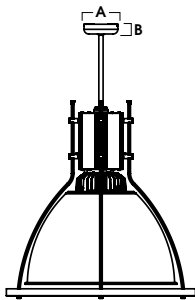

A	B
5.0	1.5
127 mm	38.1 mm

CD
CORD / CABLE MOUNT

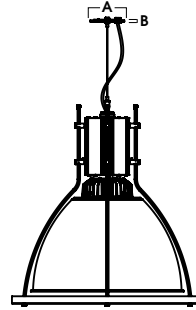

A	B
5.0	.25
63.5 mm	6.35 mm

HC
HOOK CORD

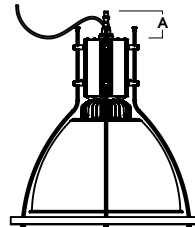

A
4.0
101.6 mm

NM
NO MOUNT

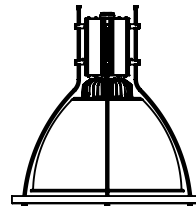



MOUNTING & ACCESSORIES

SOME OPTIONS NOT AVAILABLE ON ALL FIXTURES. CONSULT SPECIFICATION SHEETS. SEE INDIVIDUAL SPECIFICATION SHEETS OR CONSULT FACTORY FOR ADDITIONAL INFORMATION. NOTE: THIS IS TYPICAL OF RLM SPECIFICATION FOR MOUNTING. INDIVIDUAL FIXTURES OR PROJECTS MAY HAVE SPECIALIZED REQUIREMENTS.





ADDITIONS

<p>FS - FUSING</p> <p>Slow blow type fuse protects fixture against voltage surges. Factory installed.</p> 	<p>LSP10 - SM - SURGE PROTECTOR</p> <p>Surge protector absorbs transient electrical spikes and protects fixtures and electronics 120/277v. Re-sets after surge. Factory Installed.</p> 
--	---

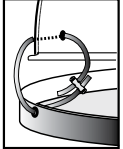



SAFETY CABLE OPTIONS

<p>SC1 - SAFETY CABLE</p> <p>1/16" stainless steel safety cable for added support. Standard kit is 18" and double barrel locks are provided. Approved for California seismic requirements. Rated at 50 lbs.</p> 	<p>SC2 - SAFETY CABLE</p> <p>1/16" Stainless steel cable holds door to fixture</p> 
--	---

OPTIONS

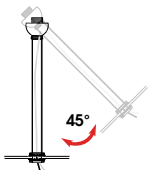
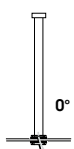
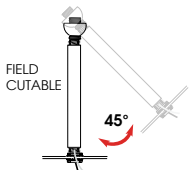
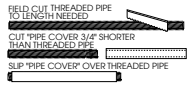
<p>DIFFUSER</p> <p>TF3-6" Frosted Diffuser</p> 	<p>TIER OPTIONS</p> <p>CFG-Center Frosted Glass Tier FGR-Frosted Glass Ring 1MR-Single Metal Ring</p>  <p>DF22 SHOWN WITH 1MR</p>
--	--

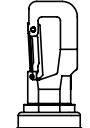
MOUNTING TYPES

<p>HM* HANG STRAIGHT 45° SWIVEL 5/8" OD STEM - 3/8" IP</p>  <p>ORDER: HM (Length) SPECIFY LENGTH: HM3 - 3" HM24 - 24" HM6 - 6" HM36 - 36" HM12 - 12" HM48 - 48" HM18 - 18" HM72 - 72" HMLC(XX) Custom Length (Specify in Inches)</p>	<p>PM* RIGID PENDANT MOUNT RIGID 5/8" OD STEM - 3/8" IP</p>  <p>ORDER: PM (Length) SPECIFY LENGTH: PM3 - 3" PM24 - 24" PM6 - 6" PM36 - 36" PM12 - 12" PM48 - 48" PM18 - 18" PM72 - 72" PMLC(XX) Custom Length (Specify in Inches)</p>	<p>AT** HANG STRAIGHT ALL THREAD 45° SWIVEL 5/8" OD STEM - 1/4" IP</p>  <p>ORDER: AT (Length) SPECIFY LENGTH: AT12 - 12" AT24 - 24" AT36 - 36"</p>  <p>*MAXIMUM ONE PIECE STEM LENGTH IS 72". **MAXIMUM ONE PIECE STEM LENGTH IS 36". LONGER LENGTHS ARE POSSIBLE USING MULTIPLE STEMS AND COUPLERS.</p>	<p>CD CORD / CABLE MOUNT SJ CORD WITH 1/16 SS CABLE</p>  <p>ORDER: CD (Length) SPECIFY LENGTH: CD36 - 36" CD72 - 72" CD144 - 144" CDLC(XX) Custom Length (Specify in Inches)</p>	<p>HC HOOK & CORD FOR INDEPENDENT MOUNTING</p>  <p>ORDER: HC (Length) SPECIFY LENGTH: HC36 - 36" HC72 - 72" HC144 - 144" HCLC(XX) Custom Length (Specify in Inches)</p>	<p>NMX 1/2" NPT Hub 3/4" NPT Hub FOR INDEPENDENT MOUNTING</p>  <p>ORDER: NMX (Length) SPECIFY LENGTH: NM2(12) - 12" Leads are Standard NM3(12) - 12" Leads are Standard NMXLC(XX) Custom Length (Specify in Inches)</p>
---	--	--	---	--	--

EMERGENCY BATTERY OPTIONS

EMCR - LARGE DRIVER CANOPY FOR 10W EMERGENCY BATTERY

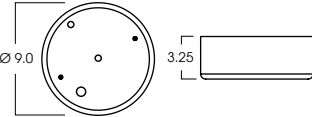

A	B	C
1.3	12.6	13.0

REMOTE EMERGENCY BATTERY OPTIONS

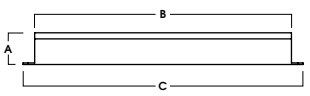
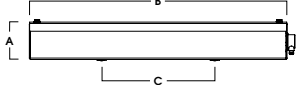
<p>EMRM* - 7W REMOTE EMERGENCY BATTERY (60' MAX)</p>  <table border="1"> <tr> <td>A</td> <td>B</td> <td>C</td> </tr> <tr> <td>1.3</td> <td>12.6</td> <td>13.0</td> </tr> </table>	A	B	C	1.3	12.6	13.0	<p>EMEN* - 7W REMOTE EMERGENCY BATTERY WITH ENCLOSURE (60' MAX)</p>  <table border="1"> <tr> <td>A</td> <td>B</td> <td>C</td> </tr> <tr> <td>2.0</td> <td>17.0</td> <td>6.2</td> </tr> </table>	A	B	C	2.0	17.0	6.2
A	B	C											
1.3	12.6	13.0											
A	B	C											
2.0	17.0	6.2											

*OTHER EM BATTERY SIZES AVAILABLE. CONSULT FACTORY

22" PRISMATIC

TECH SERIES / PHOTOMETRIC DATA



PRX22LEDLX-140L-35K-E1-PR22-CFG

CANDLEPOWER CURVE	INTENSITY	ZONAL LUMENS	SINGLE UNIT: PERFORMANCE INITIAL FOOTCANDLES BASED ON IES BEAM ANGLE				MULTIPLE UNITS: PERFORMANCE 80/50/20% REFLECTANCES INITIAL FOOTCANDLES AND WATTS PER SQUARE FOOT								
			Mounting Height AFF	FC at Center on Floor	Beam Diameter	FC at Beam Edge	Ceiling Height	Fixture Spacing	RCR 2		RCR 4		Delivered Illuminance Rating: (DIR)		
	0.00°	0° - 10°	872	8%	10.0'	76 fc	12.7'	37 fc	22'	16'	41	0.47		22	0.30
	0.00° 7,591	0° - 20°	2,871	27%	12.0'	53 fc	15.3'	26 fc	26'	18'	26	0.29	32	0.42	
	5.00° 7,766	0° - 30°	5,411	51%	14.0'	39 fc	17.8'	19 fc	32'	20'	22	0.25	18	0.25	
	10.00° 7,604	0° - 40°	7,459	70%	16.0'	30 fc	20.4'	15 fc	Delivered Illuminance Rating: (DIR)		88 FC per W/Sq. Ft.		74 FC per W/Sq. Ft.		
	15.00° 7,257	0° - 60°	9,232	87%	20.0'	19 fc	25.5'	9 fc							
	20.00° 6,593	0° - 80°	9,737	92%	24.0'	13 fc	30.6'	6 fc							
	30.00° 4,486	0° - 90°	9,853	93%	28.0'	10 fc	35.7'	5 fc							
	40.00° 2,237	Total	10,590	100%	32.0'	7 fc	40.7'	4 fc							
	50.00° 965										Lamp Multiplier: 65L x 0.67, 100L x 1.1, 130L x 1.31, 140L x 1.5				
	60.00° 454										CCT Multiplier: 50K x 1.06, 40K x 1.03, 30K x 0.979, 27K x 0.959				
	70.00° 224														
	80.00° 139														
	90.00° 62														

Delivered Lumens: 10,590
 Luminaire Watts: 111.89
 LER: 94.65

CP at 0deg (Nadir): 7,591
 CRI:

Beam Angle: 65.16
 Spacing Ratio: 1

PRX22LEDLX-140L-35K-E1-PR22-FGR

CANDLEPOWER CURVE	INTENSITY	ZONAL LUMENS	SINGLE UNIT: PERFORMANCE INITIAL FOOTCANDLES BASED ON IES BEAM ANGLE				MULTIPLE UNITS: PERFORMANCE 80/50/20% REFLECTANCES INITIAL FOOTCANDLES AND WATTS PER SQUARE FOOT								
			Mounting Height AFF	FC at Center on Floor	Beam Diameter	FC at Beam Edge	Ceiling Height	Fixture Spacing	RCR 2		RCR 4		Delivered Illuminance Rating: (DIR)		
	0.00°	0° - 10°	1,244	10%	10.0'	102 fc	12.1'	50 fc	22'	16'	51	0.47		28	0.30
	0.00° 10,222	0° - 20°	4,325	34%	12.0'	71 fc	14.5'	35 fc	26'	18'	32	0.29	41	0.42	
	5.00° 10,762	0° - 30°	8,142	63%	14.0'	52 fc	16.9'	26 fc	32'	20'	27	0.25	24	0.25	
	10.00° 11,339	0° - 40°	10,604	83%	16.0'	40 fc	19.3'	20 fc	Delivered Illuminance Rating: (DIR)		110 FC per W/Sq. Ft.		96 FC per W/Sq. Ft.		
	15.00° 11,069	0° - 60°	11,781	92%	20.0'	26 fc	24.1'	13 fc							
	20.00° 10,323	0° - 80°	12,080	94%	24.0'	18 fc	29.0'	9 fc							
	30.00° 6,242	0° - 90°	12,162	95%	28.0'	13 fc	33.8'	6 fc							
	40.00° 1,935	Total	12,846	100%	32.0'	10 fc	38.6'	5 fc							
	50.00° 603										Lamp Multiplier: 65L x 0.67, 100L x 1.1, 130L x 1.31, 140L x 1.5				
	60.00° 250										CCT Multiplier: 50K x 1.06, 40K x 1.03, 30K x 0.979, 27K x 0.959				
	70.00° 127														
	80.00° 102														
	90.00° 58														

Delivered Lumens: 12,846
 Luminaire Watts: 111.89
 LER: 114.81

CP at 0deg (Nadir): 10,222
 CRI: 85+

Beam Angle: 62.56
 Spacing Ratio: 1.05

PRX22LEDLX-140L-35K-E1-PR22-1MR

CANDLEPOWER CURVE	INTENSITY	ZONAL LUMENS	SINGLE UNIT: PERFORMANCE INITIAL FOOTCANDLES BASED ON IES BEAM ANGLE				MULTIPLE UNITS: PERFORMANCE 80/50/20% REFLECTANCES INITIAL FOOTCANDLES AND WATTS PER SQUARE FOOT								
			Mounting Height AFF	FC at Center on Floor	Beam Diameter	FC at Beam Edge	Ceiling Height	Fixture Spacing	RCR 2		RCR 4		Delivered Illuminance Rating: (DIR)		
	0.00°	0° - 10°	1,009	9%	10.0'	81 fc	12.1'	40 fc	22'	16'	43	0.47		24	0.30
	0.00° 8,132	0° - 20°	3,539	32%	12.0'	56 fc	14.5'	28 fc	26'	18'	27	0.29	34	0.42	
	5.00° 8,613	0° - 30°	6,685	60%	14.0'	41 fc	16.9'	20 fc	32'	20'	23	0.25	20	0.25	
	10.00° 9,304	0° - 40°	8,674	78%	16.0'	32 fc	19.3'	16 fc	Delivered Illuminance Rating: (DIR)		93 FC per W/Sq. Ft.		80 FC per W/Sq. Ft.		
	15.00° 9,074	0° - 60°	9,523	86%	20.0'	20 fc	24.2'	10 fc							
	20.00° 8,470	0° - 80°	9,706	88%	24.0'	14 fc	29.0'	7 fc							
	30.00° 5,134	0° - 90°	9,749	88%	28.0'	10 fc	33.8'	5 fc							
	40.00° 1,459	Total	11,061	100%	32.0'	8 fc	38.7'	4 fc							
	50.00° 430										Lamp Multiplier: 65L x 0.67, 100L x 1.1, 130L x 1.31, 140L x 1.5				
	60.00° 166										CCT Multiplier: 50K x 1.06, 40K x 1.03, 30K x 0.979, 27K x 0.959				
	70.00° 79														
	80.00° 48														
	90.00° 59														

Delivered Lumens: 11,061
 Luminaire Watts: 111.89
 LER: 98.86

CP at 0deg (Nadir): 8,132
 CRI: 85+

Beam Angle: 62.63
 Spacing Ratio: 1.06

COLOR OPTIONS - POWDER COAT PAINT FINISHES

NOTE: NO PRINTED IMAGE CAN EQUAL THE EXACT COLOR OF FINISH ON METAL.
SEE INDIVIDUAL SPECIFICATION SHEETS OR CONSULT FACTORY FOR ADDITIONAL INFORMATION.



STANDARD CORD / STEM / CANOPY FINISHES

FIXTURE COLOR	STANDARD CORD COLOR	STANDARD CANOPY / STEM COLOR
Matte White, Textured White	Matte White	Matte White
Gloss White	Matte White	Gloss White
Matte Black, Gloss Black, Textured Black	Matte Black	Matte Black
All Others	Matte Black	Same Color as Fixture
Custom Color	Contact Factory	Contact Factory

PAINT TIMES

TIER	COST	AVERAGE PAINT TIME*
Tier 1 - Standard Finishes	\$	⌚
Tier 2 - Typical Finishes	\$\$	⌚⌚
Custom Color	Contact Factory	Contact Factory

*CONTACT FACTORY FOR SPECIFIC PRODUCT LEAD TIMES

TIER 1 - STANDARD FINISHES



TIER 2 - TYPICAL FINISHES



CUSTOM COLOR FINISHES

CONTACT FACTORY

CC
Custom Color



*UNAVAILABLE FOR WET LOCATION