



22" PRISMATIC DDH SERIES



PRDDH22LX

QUICK SHIP

Quick Ship Surface highlights products that can ship in 5 - 10 working days.

APPLICATION

22" Lumen Max LX series performance pendant for mid-bay and high-bay applications. Prismatic refractor provides horizontal and vertical distribution.

FEATURES

Domed Fixture Housing (DDH) features a contemporary design and is easy to maintain. Single-stage optical system for smooth light distribution. LED module and driver designed for ease of maintenance and replacement. Posi-lock refractor retention ring will absorb shocks and impacts. Optional safety cable. Variety of optical lenses and mounting methods.

FINISH

Multi-stage polyester powder-coat process applied on our dedicated paint lines. Variety of standard and custom finishes are available. All exposed materials are chromate pretreated to resist corrosion.

ELECTRONICS

LED system features high brightness white Nichia LEDs. 3-step MacAdam Ellipse binning. Standard CRI: 80+. Higher CRI, R9 and custom LED configurations are available; consult factory. Variety of electronic 120V/277V and dimming drivers. LED module is 2 circuit with 2 drivers for multicircuit option as well as safety.

CONSTRUCTION

Housing constructed of spun and fabricated aluminum to resist corrosion. Graphite gasket for optimal thermal management. Die-cast aluminum heat sink. Refractor made of cast UV stabilized acrylic.

CODE COMPLIANCE

BAA compliant. ETL certified to meet US and Canadian standards. Suitable for dry or damp locations. Manufactured and tested to UL standards No. 1598/8750.

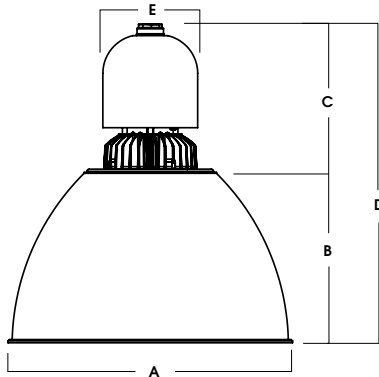

A	B	C	D	E
22.4 569.9 mm	13.6 345.4 mm	11.5 292.1 mm	25.1 637.5 mm	7.5 190.5 mm

Fixture Weight: 15.0 lbs

LUMENS / WATTAGE DATA				
PART NUMBER	SOURCE LUMENS ¹	DELIVERED LUMENS ²	SYSTEM WATTS	LPW
PRDDH22LX65L	6500	6700	59	114
PRDDH22LX100L	10000	10051	87.9	114
PRDDH22LX130L	13000	13222	117	113
PRDDH22LX140L	14000	14238	126	113

SERIES	LUMENS ¹	CCT	DRIVER / DIMMING ³	OPTIONS ⁴	MOUNTING ⁵	REFRACTOR	DIFFUSER OPTIONS	GUARD OPTION	FINISH ⁹
PRDDH22LX	65L 6500 Lm	27K 2700K	EX Electronic Driver, 120V/277V DS10X 10% 0-10V, 120V/277V DO10X 1%, 0-10V, 120V/277V DO103 1%, 0-10V, 347V	SAFETY OPTIONS FS Fusing 2CIR 2 Circuit SC1 Safety Cable SC2 Safety Cable Reflector to door EMCR 10W Canopy Mounted EM EMRM 7W Remote EM EMEN 7W Remote with Enclosure	HM ⁶ Hang Straight AT ⁷ Hang Straight All Thread PM ⁸ Rigid Pendant CD ² Cord/ Cable Mount CD72 72" Cord/ Cable Mount HC ² Hook & Cord NM2 ⁷ ½" NPT Hub NM3 ⁷ ¾" NPT Hub EMERGENCY BATTERY OPTIONS	DF22 22" Diffuse PR22 22" Clear OP22 22" Opal	TF3 - 6" Frosted Diffuser (CANNOT BE USED WITH DR OR BC OPTIONS)	WAG22 22" Wire Guard (CANNOT BE USED WITH DR OR BC OPTIONS)	MW ¹⁰ Matte White MB ¹⁰ Matte Black PT ¹⁰ Platinum Silver CC Custom Color See Page 5 for Full Range of Color Options (83-90081)
	100L 10000 Lm	30K 3000K							
	130L 13000 Lm	35K 3500K							
	140L 14000 Lm	40K 4000K							

QUICK SHIP

EXAMPLE: PRDDH22LX130L35KEX/HM36/PR22/DR22ACNFR/MW

NOTES:

1 Nominal Source Lumens at 35K 2 Nominal Delivered Lumens at 35K with DF22, No Lens 3 Contact Factory for Additional Options 4 See Product Options Page For Details 5 See Mounting Page for Details on Components and Finishes 6 Specify Length in Inches: See Mounting Page for Available Lengths 7 Mounting Supplied by Others 8 Same Finish as Housing 9 See Color Page for More Options / Consult Factory for Special Finishes 10 Standard Finishes



PROJECT: _____
TYPE: _____



Dimensions and values shown are nominal. Spectrum Lighting continually works to improve products and reserves the right to make changes which may alter the performance or appearance of products.

22" PRISMATIC

DDH SERIES / FIXTURE OPTIONS



STANDARD FINISHES

MW
MATTE WHITE



MB
MATTE BLACK



PT
PLATINUM SILVER



MOUNTING TYPES

HM / AT / PM
HANG STRAIGHT / ALL THREAD / PENDANT

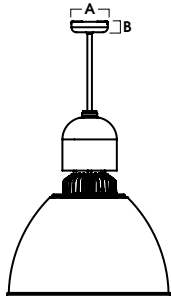

A	B
5.0	1.5
127.0 mm	38.1 mm

CD
CORD / CABLE MOUNT

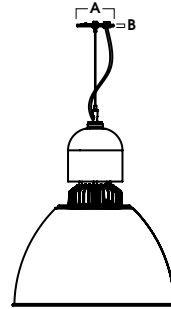

A	B
5.0	.25
127.0 mm	6.35 mm

HC
HOOK CORD

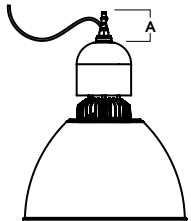

A
4.0
101.6 mm

NM
NO MOUNT

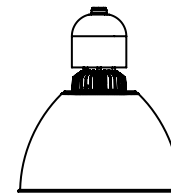

MOUNTING & ACCESSORIES

SOME OPTIONS NOT AVAILABLE ON ALL FIXTURES. CONSULT SPECIFICATION SHEETS. SEE INDIVIDUAL SPECIFICATION SHEETS OR CONSULT FACTORY FOR ADDITIONAL INFORMATION. NOTE: THIS IS TYPICAL OF RLM SPECIFICATION FOR MOUNTING. INDIVIDUAL FIXTURES OR PROJECTS MAY HAVE SPECIALIZED REQUIREMENTS.



ADDITIONS

FS - FUSING

Slow blow type fuse protects fixture against voltage surges. Factory installed.



LSP10 - SM - SURGE PROTECTOR

Surge protector absorbs transient electrical spikes and protects fixtures and electronics 120/277v. Re-sets after surge. Factory Installed.



SAFETY CABLE OPTIONS

SC1 - SAFETY CABLE

1/16" stainless steel safety cable for added support. Standard kit is 18" and double barrel locks are provided. Approved for California seismic requirements. Rated at 50 lbs.



SC2 - SAFETY CABLE

1/16" Stainless steel cable holds door to fixture

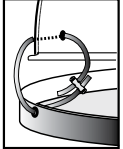

OPTIONS

DIFFUSER

TF3-6" Frosted Diffuser



DOOR

DR22A-22" Spun Door
BC22-22" Band Clamp



DR22A SHOWN WITH CN

LENSES





CNFR-Conical Frosted Lens
CN-Conical Lens
DL-Drop Lens
FO-White Optical Acrylic
PP-Prismatic Polycarbonate
PC-Clear Polycarbonate

GUARD OPTION

WAG22-22" Wire Guard

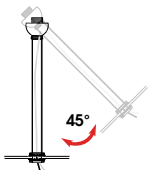
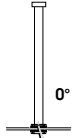
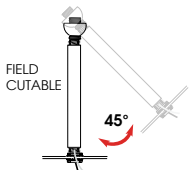
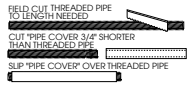

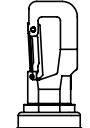
MOUNTING TYPES

<p>HM* HANG STRAIGHT 45° SWIVEL 5/8" OD STEM - 3/8" IP</p>  <p>ORDER: HM (Length) SPECIFY LENGTH: HM3 - 3" HM24 - 24" HM6 - 6" HM36 - 36" HM12 - 12" HM48 - 48" HM18 - 18" HM72 - 72" HMLC(XX) Custom Length (Specify in Inches)</p>	<p>PM* RIGID PENDANT MOUNT RIGID 5/8" OD STEM - 3/8" IP</p>  <p>ORDER: PM (Length) SPECIFY LENGTH: PM3 - 3" PM24 - 24" PM6 - 6" PM36 - 36" PM12 - 12" PM48 - 48" PM18 - 18" PM72 - 72" PMLC(XX) Custom Length (Specify in Inches)</p>	<p>AT** HANG STRAIGHT ALL THREAD 45° SWIVEL 5/8" OD STEM - 1/4" IP</p>  <p>ORDER: AT (Length) SPECIFY LENGTH: AT12 - 12" AT24 - 24" AT36 - 36"</p>  <p style="font-size: x-small;">FIELD CUT THREADED PIPE TO LENGTH NEEDED CUT PIPE COVER 3/4" SHORTER THAN THREADED PIPE SLIP PIPE COVER OVER THREADED PIPE</p>	<p>CD CORD / CABLE MOUNT SJ CORD WITH 1/16 SS CABLE</p>  <p>ORDER: CD (Length) SPECIFY LENGTH: CD36 - 36" CD72 - 72" CD144 - 144" CDLC(XX) Custom Length (Specify in Inches)</p>	<p>HC HOOK & CORD FOR INDEPENDENT MOUNTING</p>  <p>ORDER: HC (Length) SPECIFY LENGTH: HC36 - 36" HC72 - 72" HC144 - 144" HCLC(XX) Custom Length (Specify in Inches)</p>	<p>NMX 1/2" NPT Hub 3/4" NPT Hub FOR INDEPENDENT MOUNTING</p>  <p>ORDER: NMX (Length) SPECIFY LENGTH: NM2(12) - 12" Leads are Standard NM3(12) - 12" Leads are Standard NMXL(XX) Custom Length (Specify in Inches)</p>
--	---	--	---	--	--

*MAXIMUM ONE PIECE STEM LENGTH IS 72". **MAXIMUM ONE PIECE STEM LENGTH IS 36". LONGER LENGTHS ARE POSSIBLE USING MULTIPLE STEMS AND COUPLERS.

EMERGENCY BATTERY OPTIONS

EMCR - LARGE DRIVER CANOPY FOR 10W EMERGENCY BATTERY

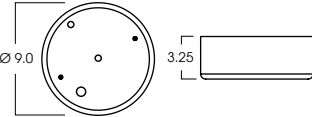

A	B	C
1.3	12.6	13.0

REMOTE EMERGENCY BATTERY OPTIONS

EMRM* - 7W REMOTE EMERGENCY BATTERY (60' MAX)

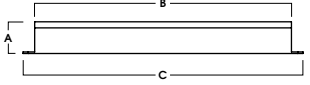

A	B	C
1.3	12.6	13.0

EMEN* - 7W REMOTE EMERGENCY BATTERY WITH ENCLOSURE (60' MAX)

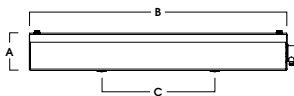

A	B	C
2.0	17.0	6.2

*OTHER EM BATTERY SIZES AVAILABLE. CONSULT FACTORY

22" PRISMATIC

DDH SERIES / PHOTOMETRIC DATA



PRxxx22LX-140L-35K-EX-DF22

CANDLEPOWER CURVE	INTENSITY	ZONAL LUMENS	SINGLE UNIT: PERFORMANCE INITIAL FOOTCANDLES BASED ON IES BEAM ANGLE		MULTIPLE UNITS: PERFORMANCE 80/50/20% REFLECTANCES INITIAL FOOTCANDLES AND WATTS PER SQUARE FOOT							
	0.00°	0° - 10°	776	5%	Mounting Height	FC at Center on Floor	Ceiling Height	Fixture Spacing	RCR 2		RCR 4	
	0.00° 7,914	0° - 20°	2,974	21%	AFF	FC on Floor			FC +	W/Sq. Ft.	FC +	W/Sq. Ft.
	20.00° 7,314	0° - 30°	6,050	43%	10.0'	79 fc	22'	20' *	33	0.34	28	0.34
	40.00° 2,734	0° - 40°	9,018	63%	12.0'	55 fc	26'	22' **	21	0.21	18	0.21
	60.00° 856	0° - 60°	10,965	77%	14.0'	40 fc	32'	24' ***	19	0.19	23	0.28
	80.00° 486	0° - 80°	12,315	87%	16.0'	31 fc	Delivered Illuminance Rating: (DIR)		100 FC per W/Sq. Ft.		83 FC per W/Sq. Ft.	
	90.00° 352	0° - 90°	12,767	90%	20.0'	20 fc	2' Suspension Length Square rooms used for multiple units: - RCR 2: Length & Width = Ceiling Ht. - 6.5' x 5.00 - RCR 4: Length & Width = Ceiling Ht. - 6.5' x 2.50 * Average Footcandles at 2.5' Above Floor * Exceeds spacing criteria by 14% ** Exceeds spacing criteria by -0% *** Exceeds spacing criteria by -17%					
	100.00° 278	Total	14,229	100%	24.0'	14 fc						
	110.00° 229											
	120.00° 201											
	140.00° 200											
	160.00° 225											
	180.00° 216											
	Delivered Lumens: 14,229 Luminaire Watts: 126 LER: 112.93	CP at 0deg (Nadir): 7,914 CRI: 85+	Lamp Multiplier: 65L x 0.47, 100L x 0.71, 130L x 0.93 CCT Multiplier: 40K x 1.03, 30K x 0.979, 27K x 0.959									

PRxxx22LEDLX-140L-35K-E1-XXXX-PR22

CANDLEPOWER CURVE	INTENSITY	ZONAL LUMENS	SINGLE UNIT: PERFORMANCE INITIAL FOOTCANDLES BASED ON IES BEAM ANGLE		MULTIPLE UNITS: PERFORMANCE 80/50/20% REFLECTANCES INITIAL FOOTCANDLES AND WATTS PER SQUARE FOOT							
	0.00°	0° - 10°	1,033	8%	Mounting Height	FC at Center on Floor	Ceiling Height	Fixture Spacing	RCR 2		RCR 4	
	0.00° 9,341	0° - 20°	4,060	33%	AFF	FC on Floor			FC +	W/Sq. Ft.	FC +	W/Sq. Ft.
	20.00° 10,049	0° - 30°	7,872	65%	10.0'	93 fc	22'	16' *	49	0.52	27	0.34
	40.00° 1,737	0° - 40°	10,281	84%	12.0'	65 fc	26'	18' **	31	0.33	39	0.48
	60.00° 221	0° - 60°	11,264	92%	14.0'	48 fc	32'	20' ***	26	0.28	23	0.28
	80.00° 107	0° - 80°	11,542	95%	16.0'	36 fc	Delivered Illuminance Rating: (DIR)		93 FC per W/Sq. Ft.		81 FC per W/Sq. Ft.	
	90.00° 55	0° - 90°	11,621	95%	20.0'	23 fc	2' Suspension Length Square rooms used for multiple units: - RCR 2: Length & Width = Ceiling Ht. - 6.5' x 5.00 - RCR 4: Length & Width = Ceiling Ht. - 6.5' x 2.50 * Average Footcandles at 2.5' Above Floor * Exceeds spacing criteria by -4% ** Exceeds spacing criteria by -14% *** Exceeds spacing criteria by -27%					
	100.00° 55	Total	12,193	100%	24.0'	16 fc						
	110.00° 73											
	120.00° 71											
	140.00° 121											
	160.00° 172											
	180.00° 206											
	Delivered Lumens: 12,193 Luminaire Watts: 126 LER: 96.77	CP at 0deg (Nadir): 9,341 CRI: 85	Lamp Multiplier: 65L x 0.67, 100L x 1, 130L x 1.32, 140L x 1.42 CCT Multiplier: 40K x 1.03, 30K x 0.98, 27K x 0.96									

PRxxx22LEDLX-140L-35K-EX-xxxx-DF22-DR22-FO

CANDLEPOWER CURVE	INTENSITY	ZONAL LUMENS	SINGLE UNIT: PERFORMANCE INITIAL FOOTCANDLES BASED ON IES BEAM ANGLE				MULTIPLE UNITS: PERFORMANCE 80/50/20% REFLECTANCES INITIAL FOOTCANDLES AND WATTS PER SQUARE FOOT							
	0.00°	0° - 10°	355	4%	Mounting Height	FC at Center on Floor	Beam Diameter	FC at Beam Edge	Ceiling Height	Fixture Spacing	RCR 2		RCR 4	
	0.00° 3,601	0° - 20°	1,286	13%	AFF	FC on Floor					FC +	W/Sq. Ft.	FC +	W/Sq. Ft.
	5.00° 3,585	0° - 30°	2,646	27%	10.0'	36 fc	23.4'	14 fc	22'	20' *	22	0.30	18	0.30
	10.00° 3,389	0° - 40°	4,234	43%	12.0'	25 fc	28.1'	10 fc	26'	22' **	14	0.19	11	0.19
	15.00° 3,311	0° - 60°	7,149	72%	14.0'	18 fc	32.8'	7 fc	32'	24' ***	13	0.17	15	0.25
	20.00° 3,153	0° - 80°	8,543	86%	16.0'	14 fc	37.5'	6 fc	Delivered Illuminance Rating: (DIR)		75 FC per W/Sq. Ft.		59 FC per W/Sq. Ft.	
	30.00° 2,785	0° - 90°	8,636	87%	20.0'	9 fc	46.9'	4 fc	2' Suspension Length Square rooms used for multiple units: - RCR 2: Length & Width = Ceiling Ht. - 6.5' x 5.00 - RCR 4: Length & Width = Ceiling Ht. - 6.5' x 2.50 * Average Footcandles at 2.5' Above Floor * Exceeds spacing criteria by 12% ** Exceeds spacing criteria by -2% *** Exceeds spacing criteria by -18%					
	40.00° 2,319	Total	9,926	100%	24.0'	6 fc	56.3'	3 fc						
	50.00° 1,773													
	60.00° 1,209													
	70.00° 674													
	80.00° 204													
	90.00° 7													
	Delivered Lumens: 9,926 Luminaire Watts: 111.89 LER: 88.71	CP at 0deg (Nadir): 3,601 CRI: 85	Beam Angle: 98.96 Spacing Ratio: 1.15	Lamp Multiplier: 65L x 0.67, 100L x 1, 130L x 1.2 CCT Multiplier: 40K x 1.03, 30K x 0.979, 27K x 0.959										

COLOR OPTIONS - POWDER COAT PAINT FINISHES

NOTE: NO PRINTED IMAGE CAN EQUAL THE EXACT COLOR OF FINISH ON METAL.
SEE INDIVIDUAL SPECIFICATION SHEETS OR CONSULT FACTORY FOR ADDITIONAL INFORMATION.



STANDARD CORD / STEM / CANOPY FINISHES

FIXTURE COLOR	STANDARD CORD COLOR	STANDARD CANOPY / STEM COLOR
Matte White, Textured White	Matte White	Matte White
Gloss White	Matte White	Gloss White
Matte Black, Gloss Black, Textured Black	Matte Black	Matte Black
All Others	Matte Black	Same Color as Fixture
Custom Color	Contact Factory	Contact Factory

PAINT TIMES

TIER	COST	AVERAGE PAINT TIME*
Tier 1 - Standard Finishes	\$	⌚
Tier 2 - Typical Finishes	\$\$	⌚⌚
Custom Color	Contact Factory	Contact Factory

*CONTACT FACTORY FOR SPECIFIC PRODUCT LEAD TIMES

TIER 1 - STANDARD FINISHES

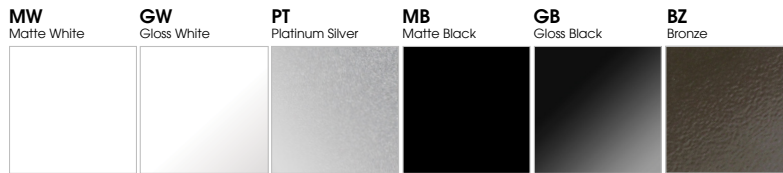

TIER 2 - TYPICAL FINISHES



CUSTOM COLOR FINISHES

CONTACT FACTORY

CC
Custom Color



*UNAVAILABLE FOR WET LOCATION